

© eviack

~~“Unsupervised”~~ *Self Supervised*
Deep Learning

James Hays

slides from Carl Doersch and Richard Zhang

Recap: Fully Convolutional Network

Design network as a bunch of convolutional layers, with **downsampling** and **upsampling** inside the network!

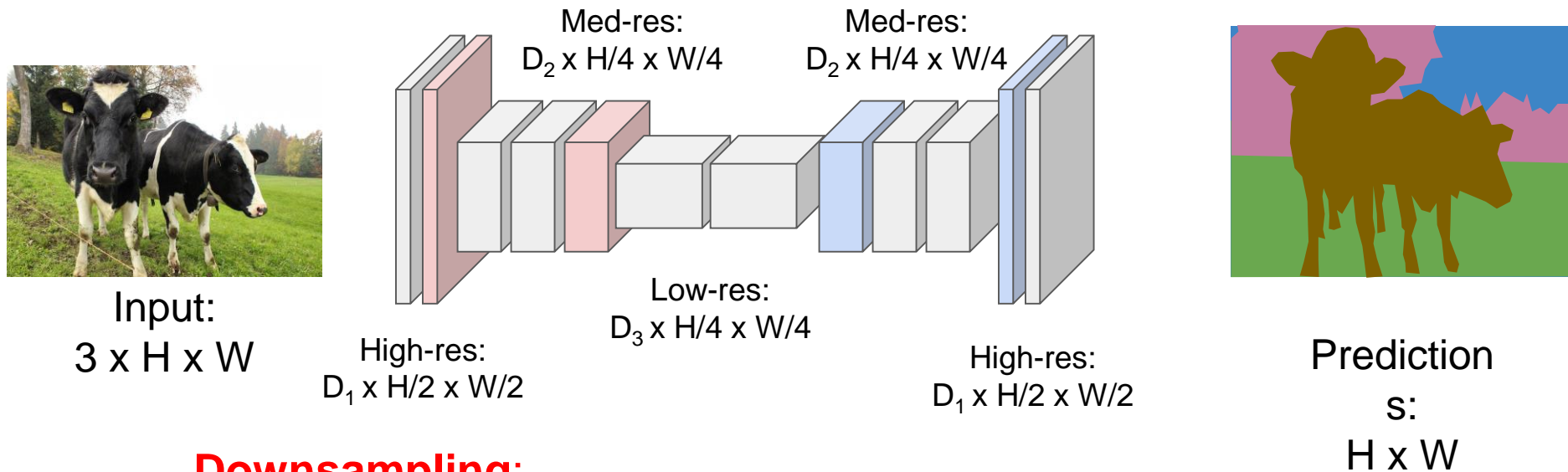

Downsampling:
Pooling, strided
convolution

Upsampling:
???

Long, Shelhamer, and Darrell, "Fully Convolutional Networks for Semantic Segmentation",
CVPR 2015
Noh et al, "Learning Deconvolution Network for Semantic Segmentation", ICCV 2015

Recap: Pyramid Scene Parsing Network

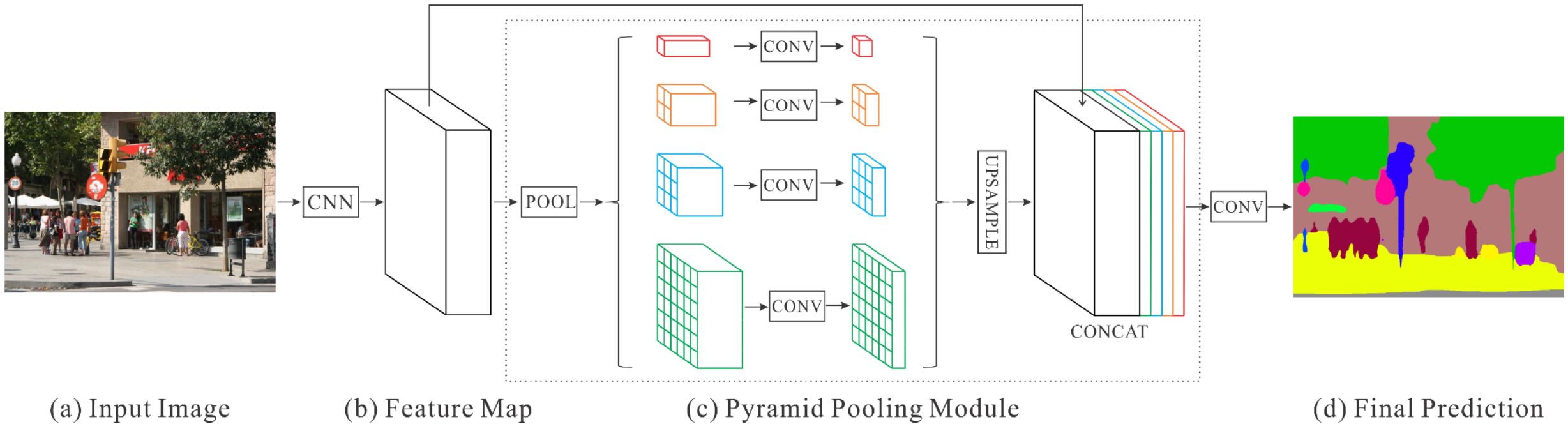

Framework overview of PSPNet

"Pyramid Scene Parsing Network", Zhao et al. CVPR 2017 [15,000+ citation]

Slide Credit: Hengshuang Zhao and Jiaya Jia

Recap

Big Data

- The Unreasonable Effectiveness of Data
- Scene Completion
- Im2gps
- Recognition via Tiny Images

Crowdsourcing

- “Wisdom of the Crowds” / consensus
- Find good annotators through grading
- Pricing affects throughput but not quality
- User interface and instructions matter a lot

Today's Lecture

- Four methods for “unsupervised” deep learning
 - Context Prediction. Doersch et al. ICCV 2015
 - Colorful Image Colorization. Zhang et al. ECCV 2016
 - SimCLR. Chen et al. ICML 2020
 - Masked Autoencoders. He et al. CVPR 2022
- Big picture: do we need big, labeled datasets like ImageNet to make deep learning worthwhile? Can we learn from something else?

**I'd love to go back in time
and blow people's minds
with my incredible knowledge!**

But how do
you make this
'Electricity'?

I don't
know

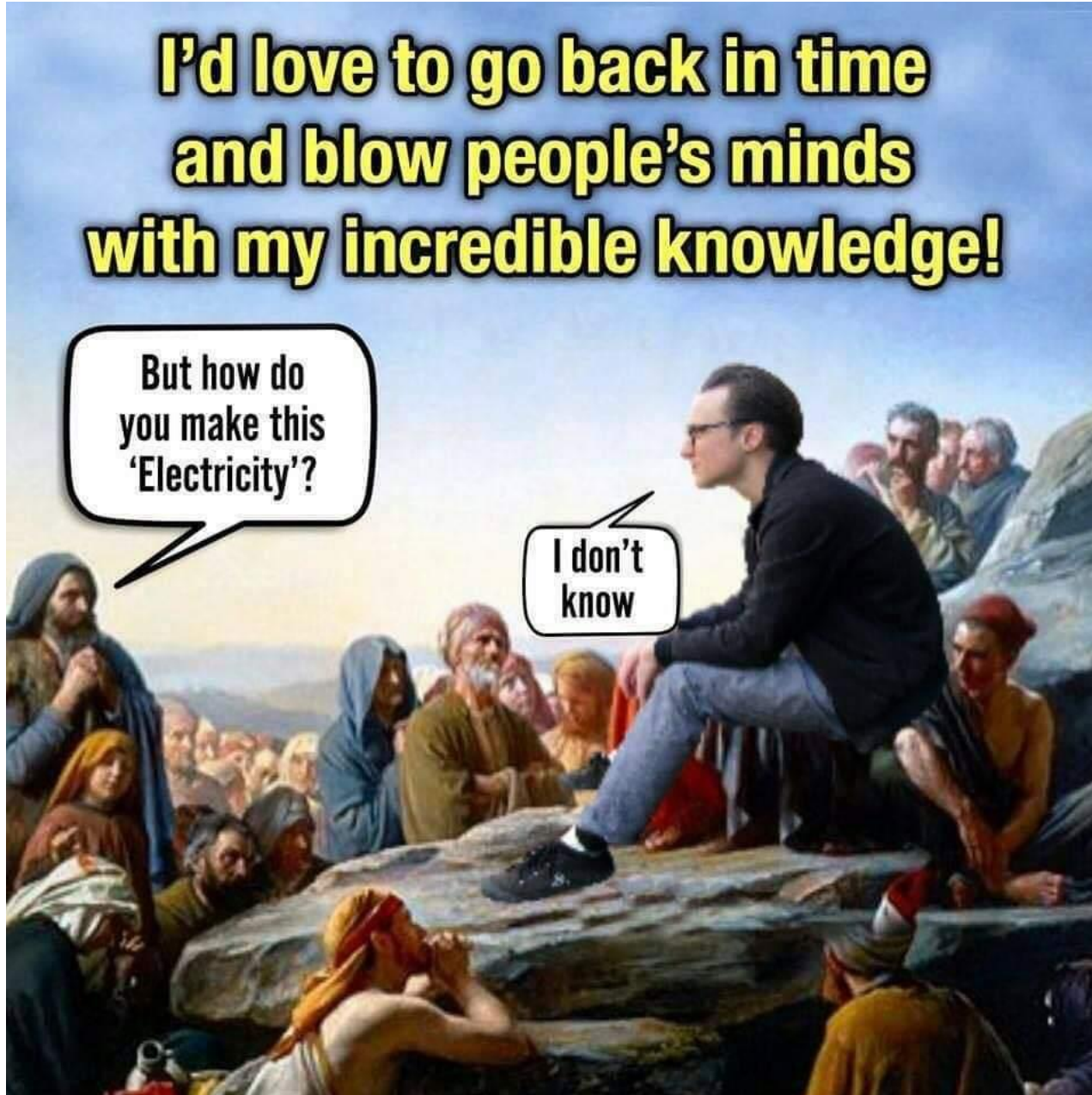

The Gelato Bet

"If, by the first day of autumn (Sept 23) of 2015, a method will exist that can match or beat the performance of R-CNN on Pascal VOC detection, without the use of any extra, human annotations (e.g. ImageNet) as pre-training, Mr. Malik promises to buy Mr. Efros one (1) gelato"

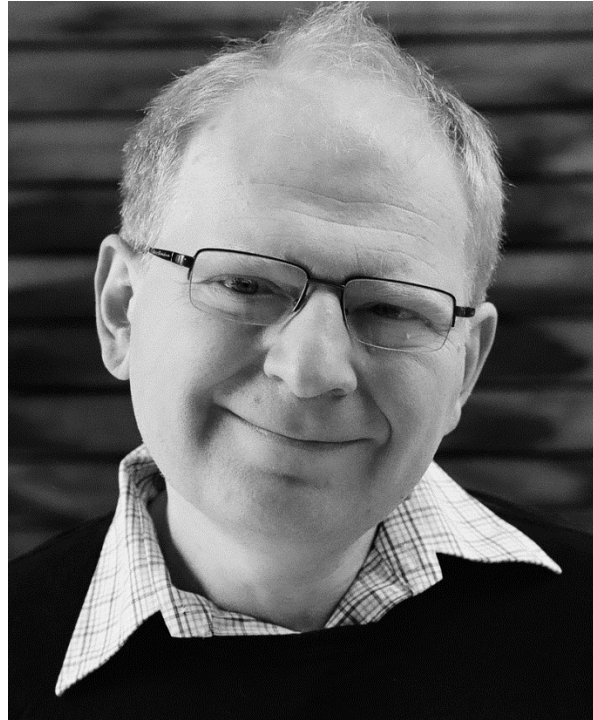

Unsupervised Visual Representation Learning by Context Prediction

Carl Doersch, Alexei A. Efros, and Abhinav Gupta

ICCV 2015

ImageNet + Deep Learning

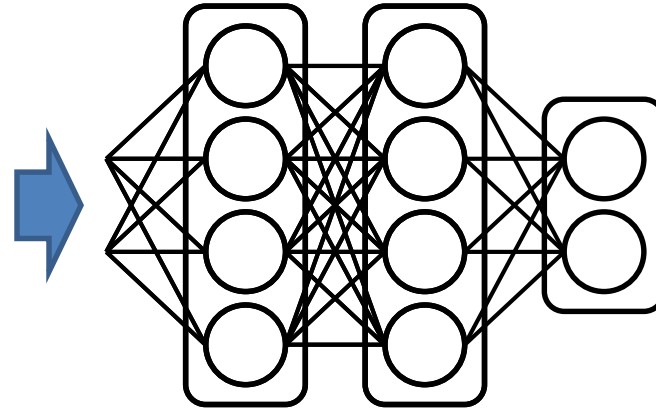

Beagle



- Image Retrieval
- Detection (RCNN)
- Segmentation (FCN)
- Depth Estimation
- ...

ImageNet + Deep Learning

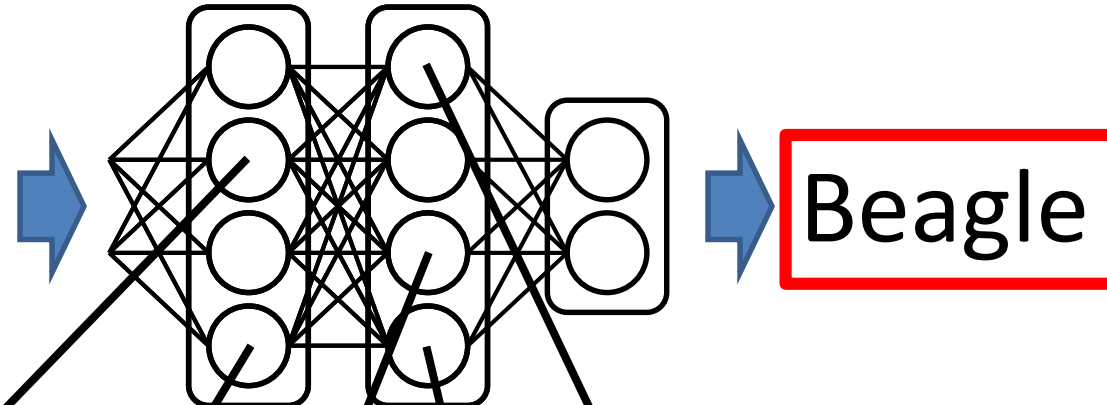

Materials?

Parts?

Pose?

Do we even need this sort of labels?

Geometry?

Boundaries?

Context as Supervision

[Collobert & Weston 2008; Mikolov et al. 2013 (Word2Vec)]

house, where the professor lived without his wife and child; or so he said jokingly sometimes: "Here's where I live. My house." His daughter often added, without resentment, for the visitor's information, "It started out to be for me, but it's really his." And she might reach in to bring forth an inch-high table lamp with fluted shade, or a blue dish the size of her little fingernail, marked "Kitty" and half full of eternal milk, but she was sure to replace these, after they had been admired, pretty near exactly where they had been. The little house was very orderly, and just big enough for all it contained, though to some tastes the bric-à-brac in the parlor might seem excessive. The daughter's preference was for the store-bought gimmicks and appliances, the toasters and carpet sweepers of Lilliput, but she knew that most adult visitors would

Deep
Net

Context Prediction for Images

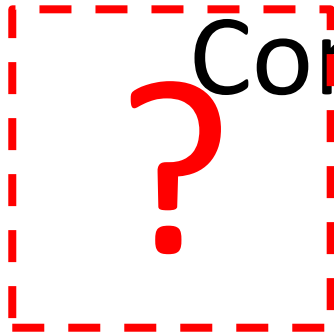

A

B

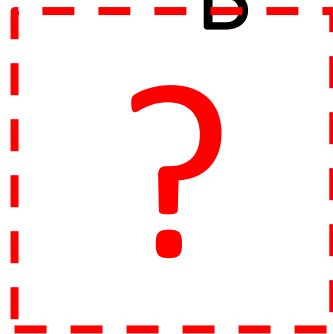
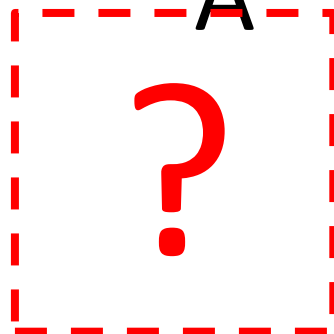
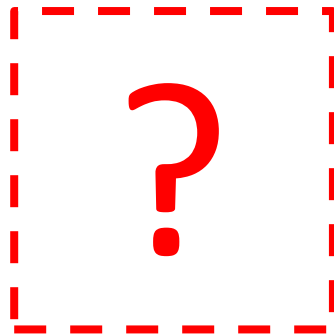

Semantics from a non-semantic task

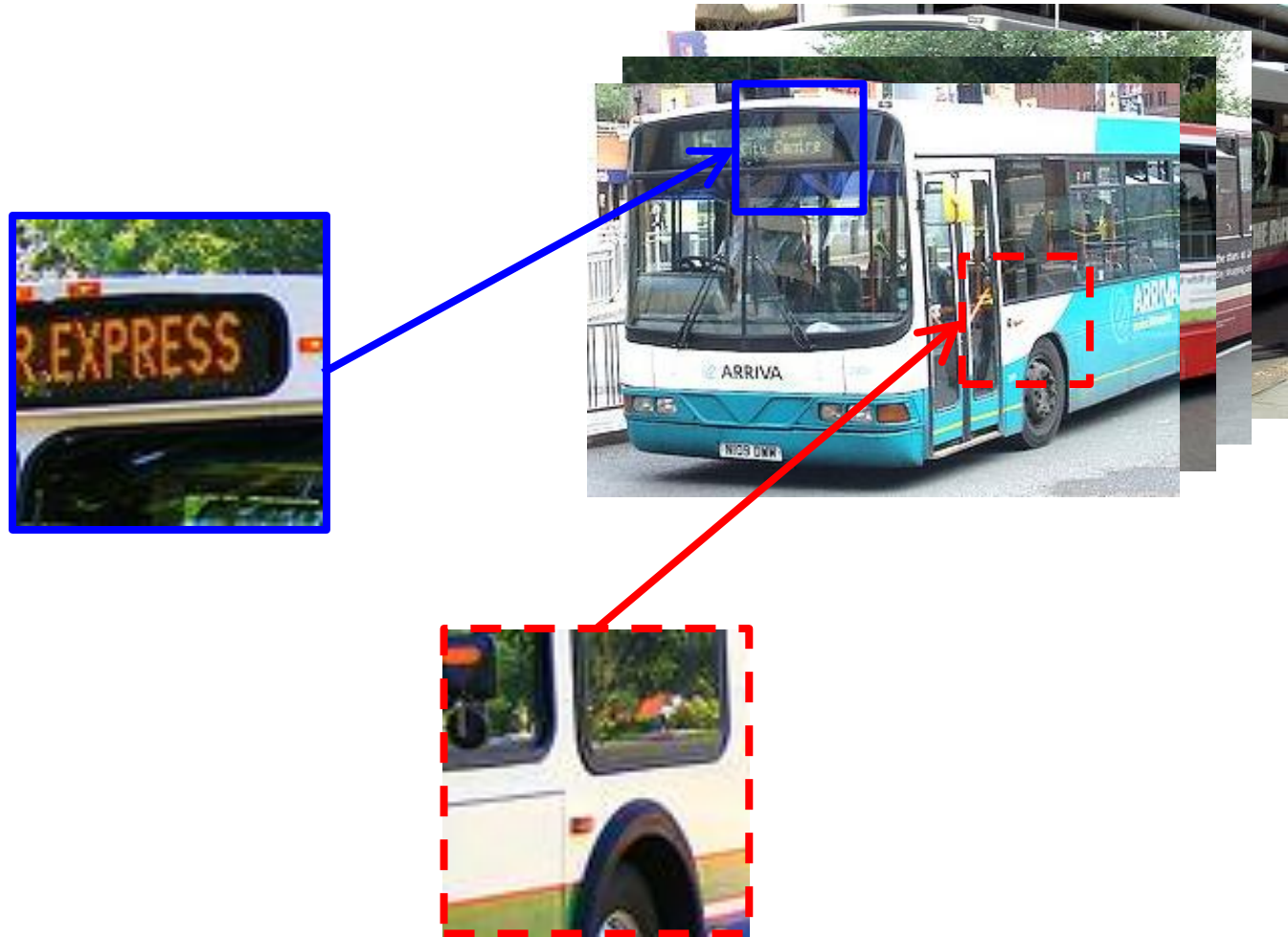

Relative Position Task

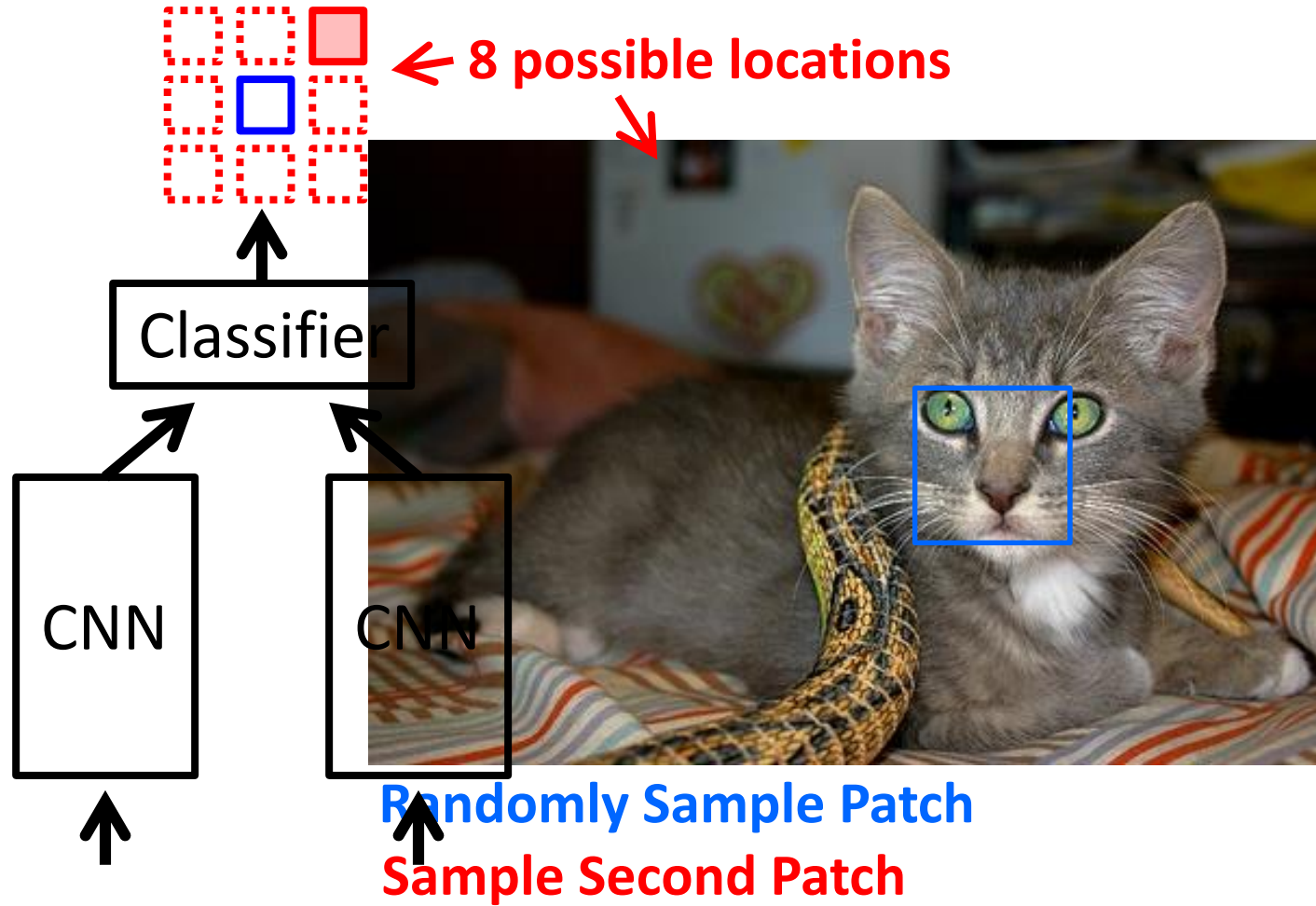

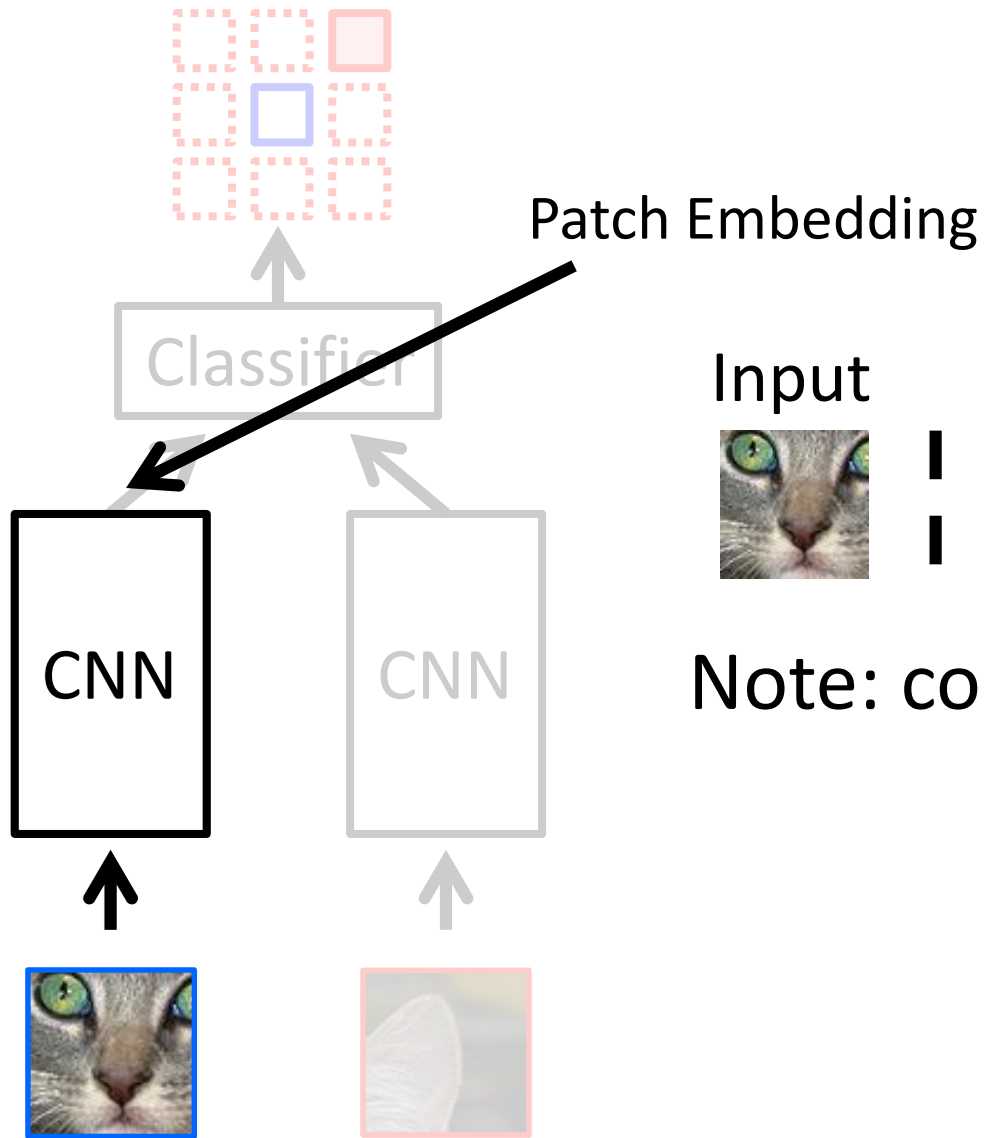

Input



!

Nearest Neighbors

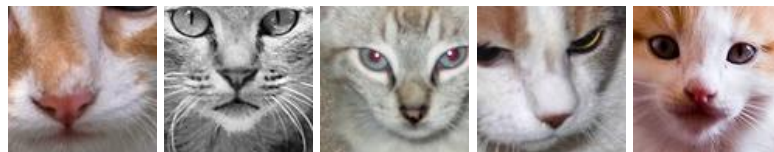

Note: connects ***across*** instances!

Architecture

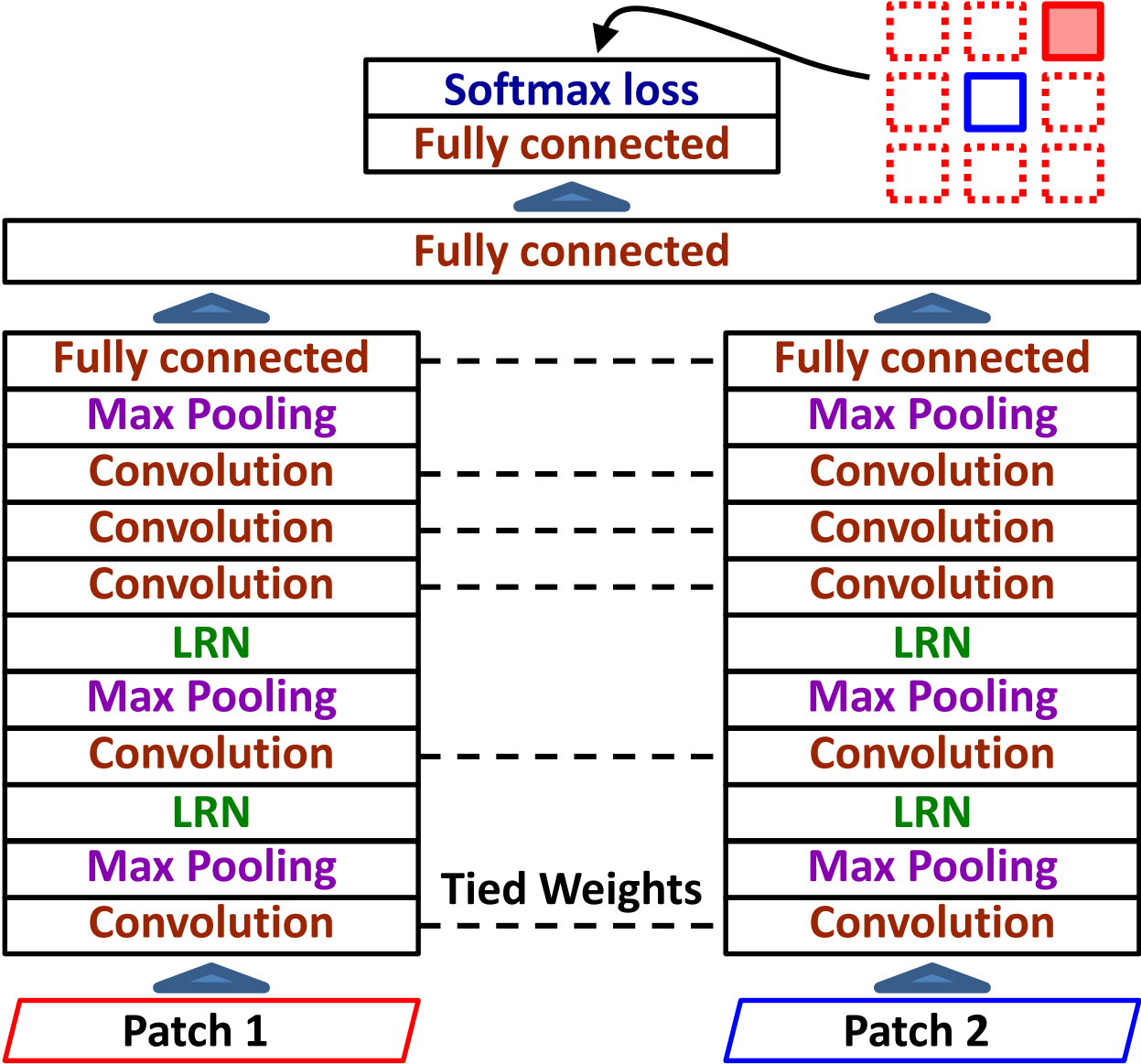

Avoiding Trivial Shortcuts

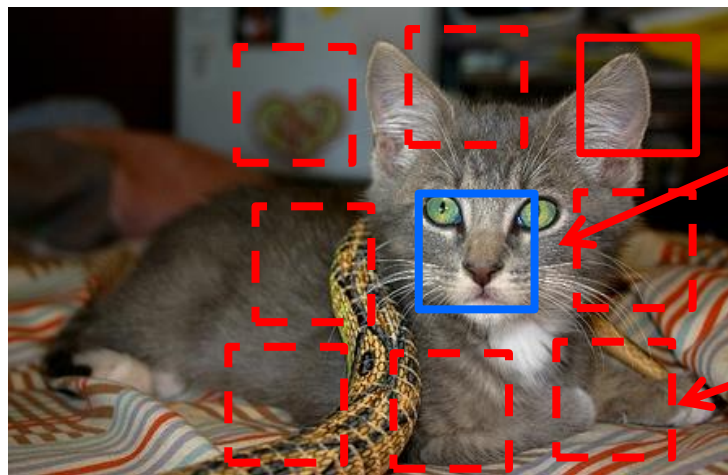
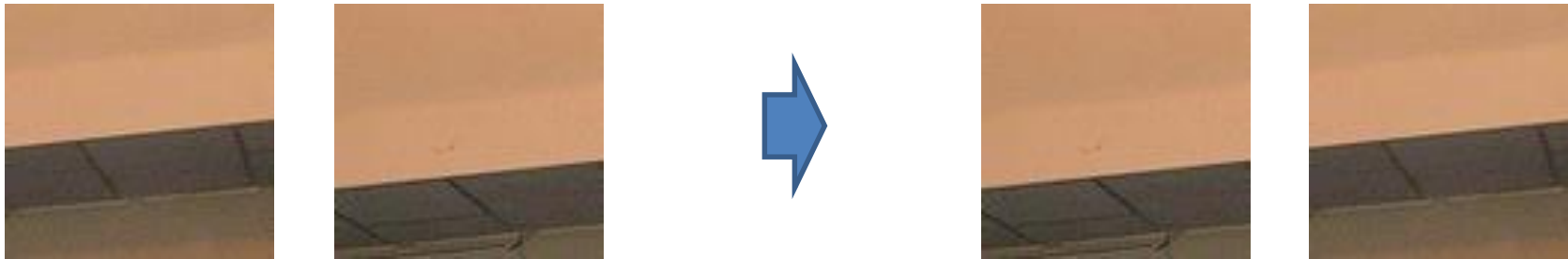

Include a gap

Jitter the patch locations

A Not-So “Trivial” Shortcut

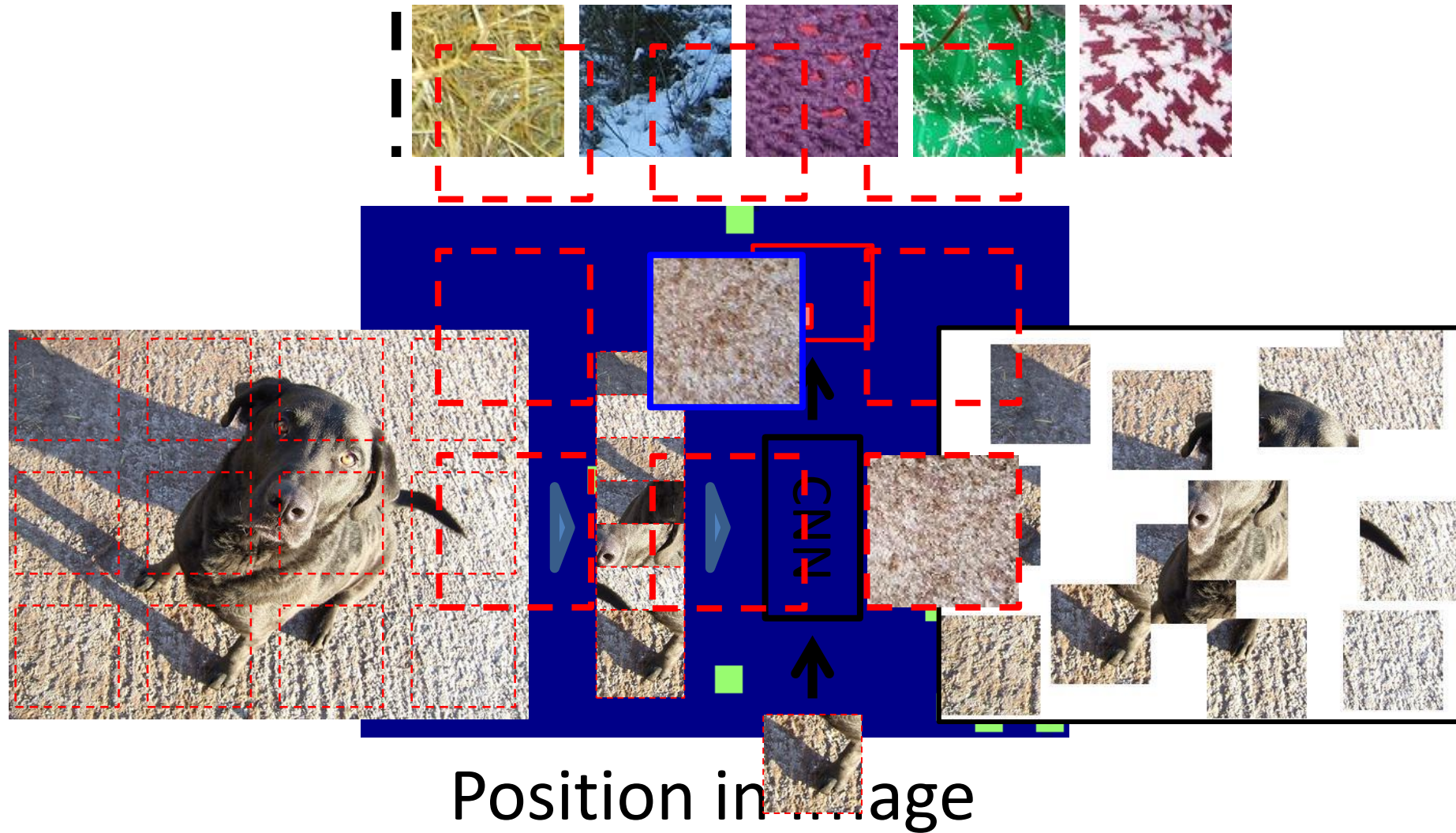

Chromatic Aberration

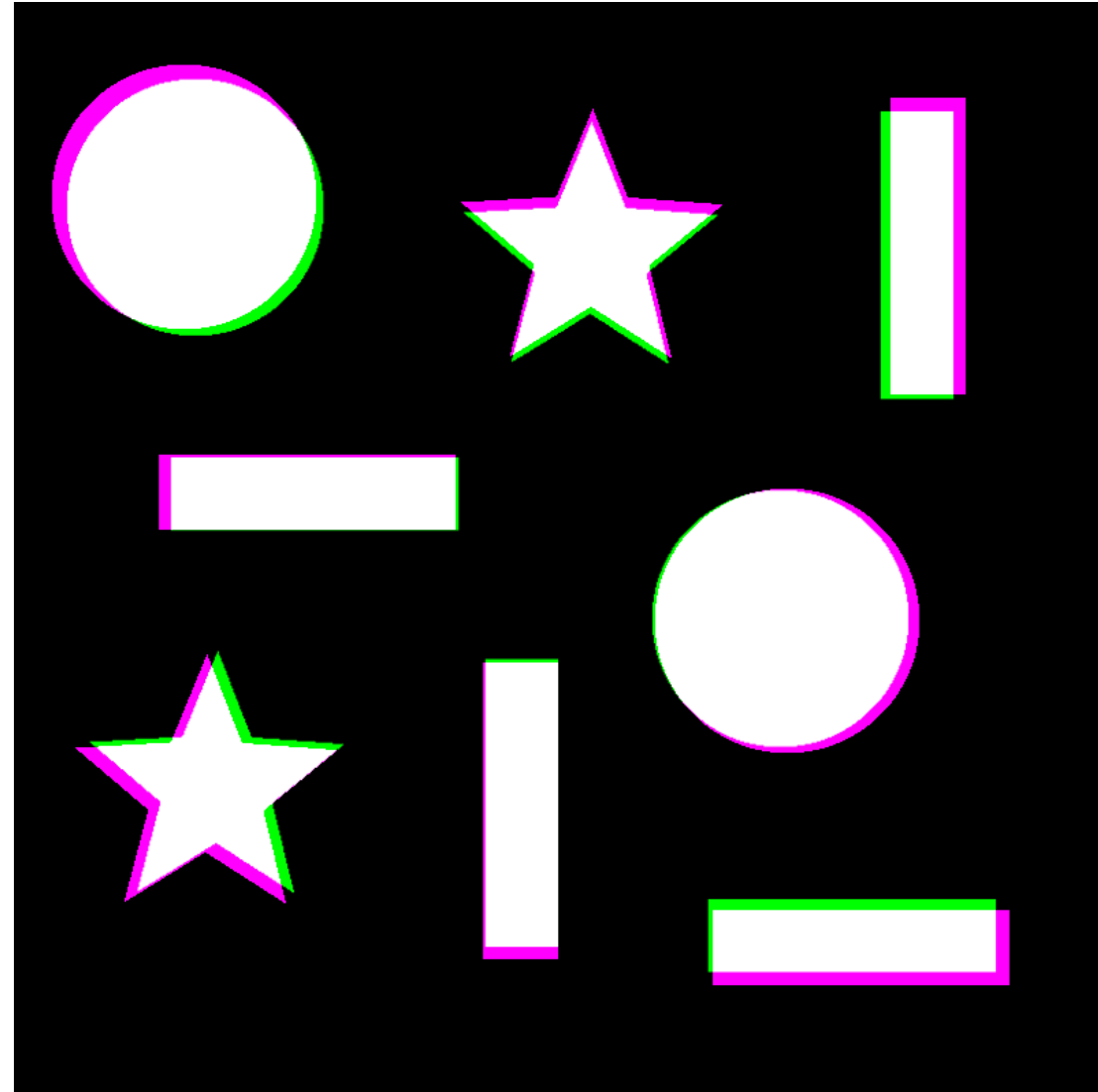
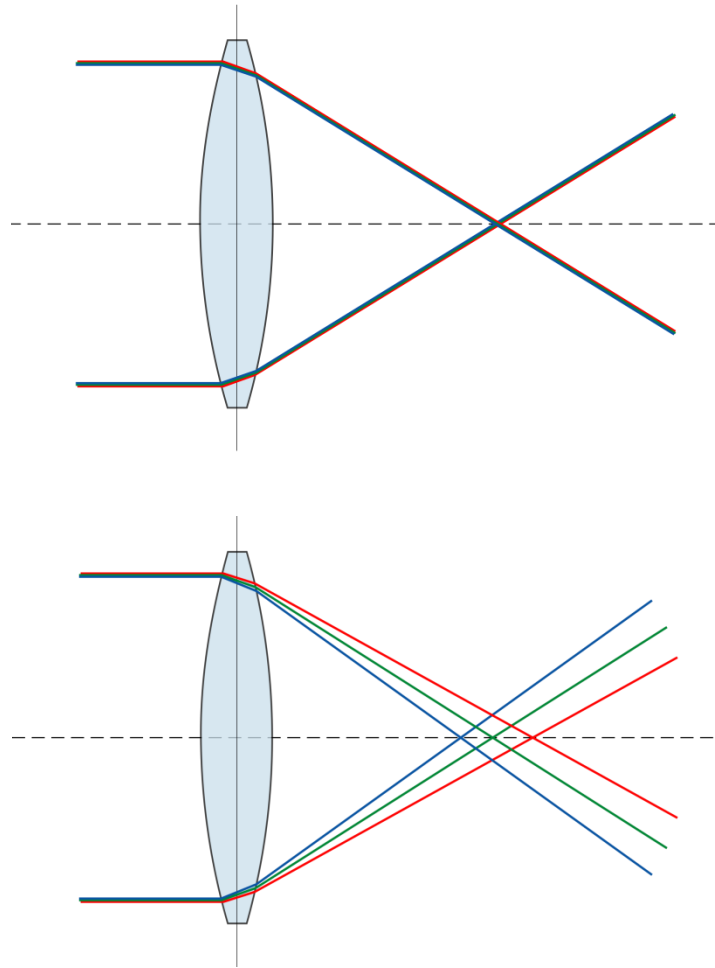

Chromatic Aberration

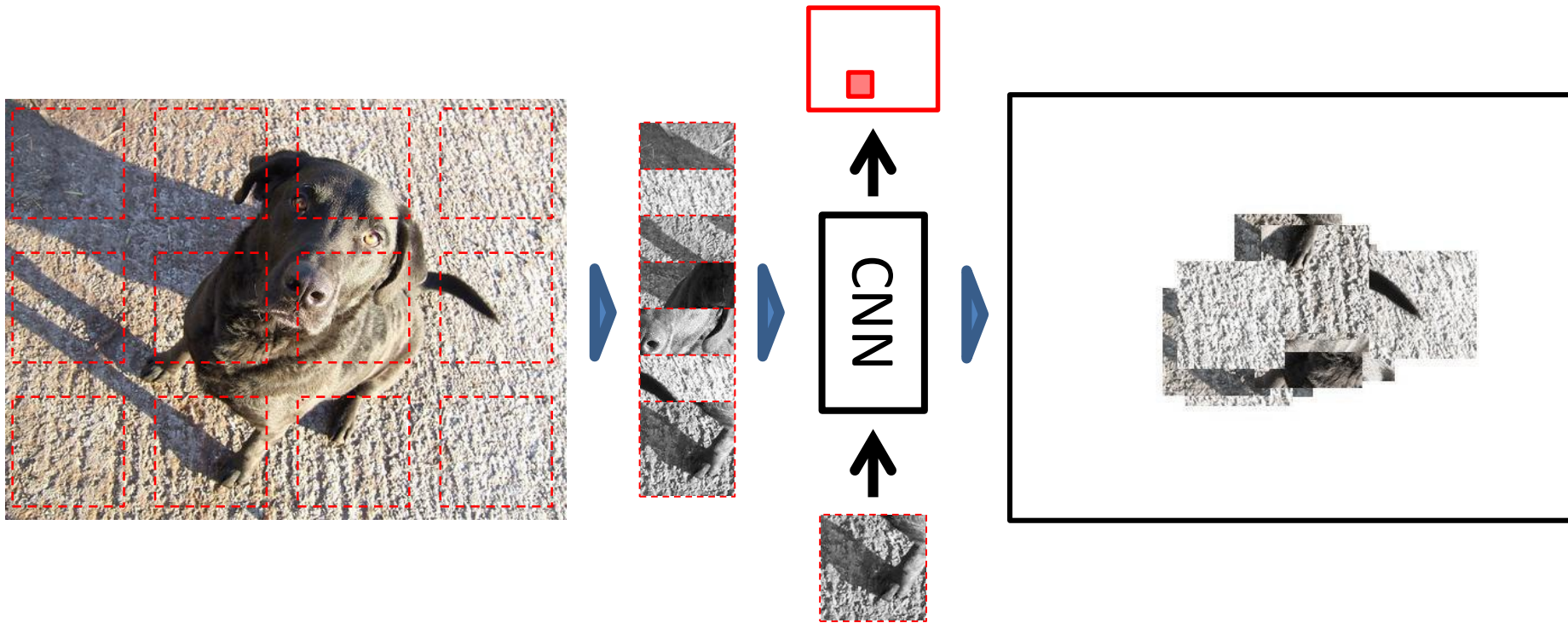
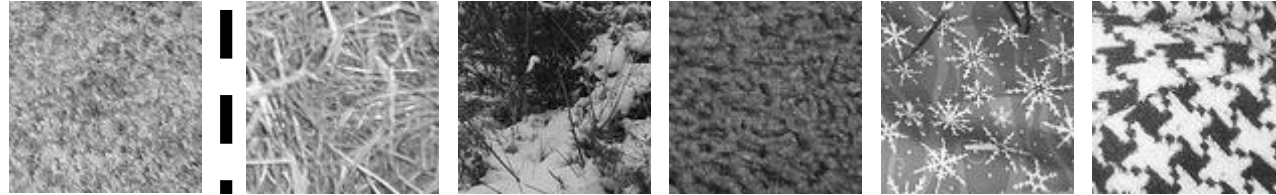

What is learned?

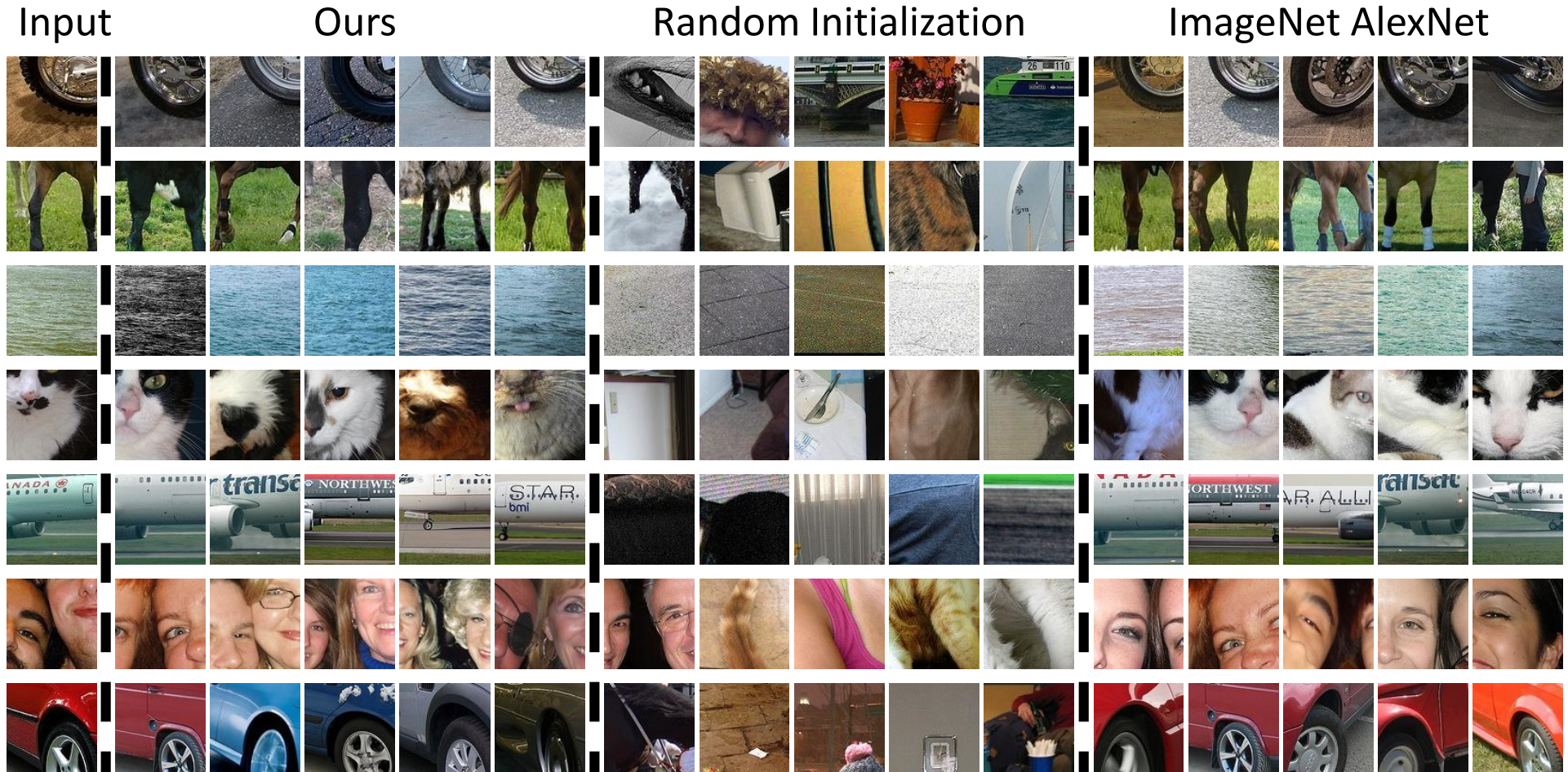

Still don't capture everything

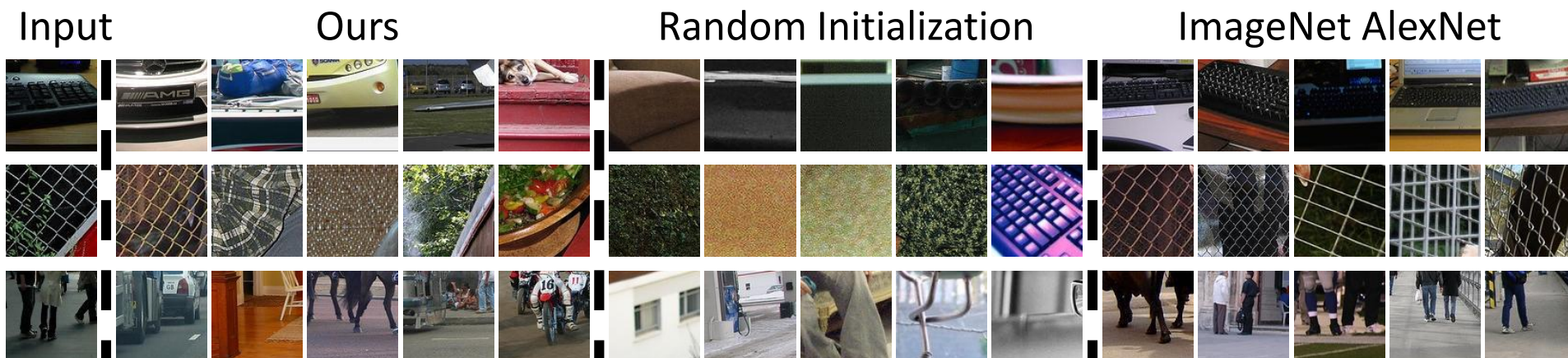

You don't always need to learn!

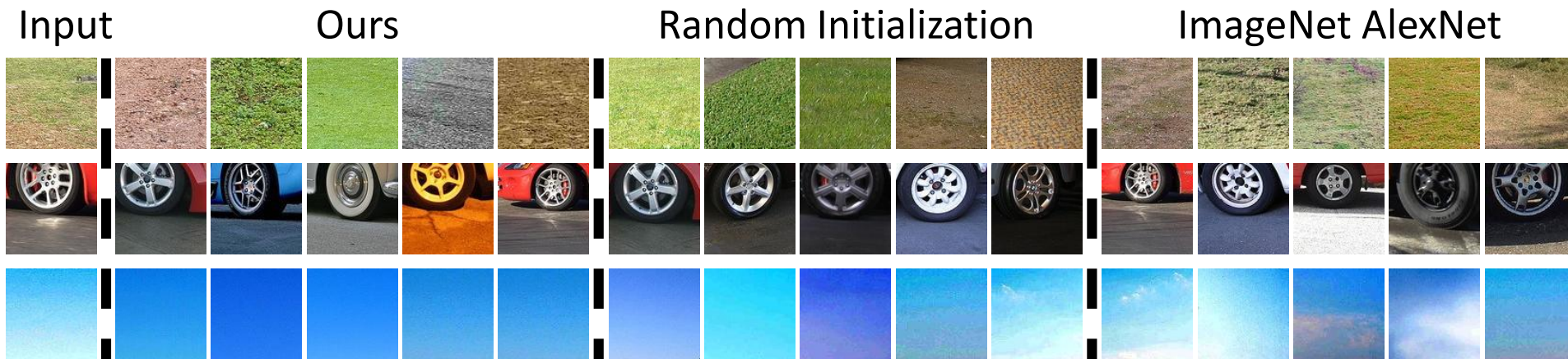

Pre-Training for R-CNN

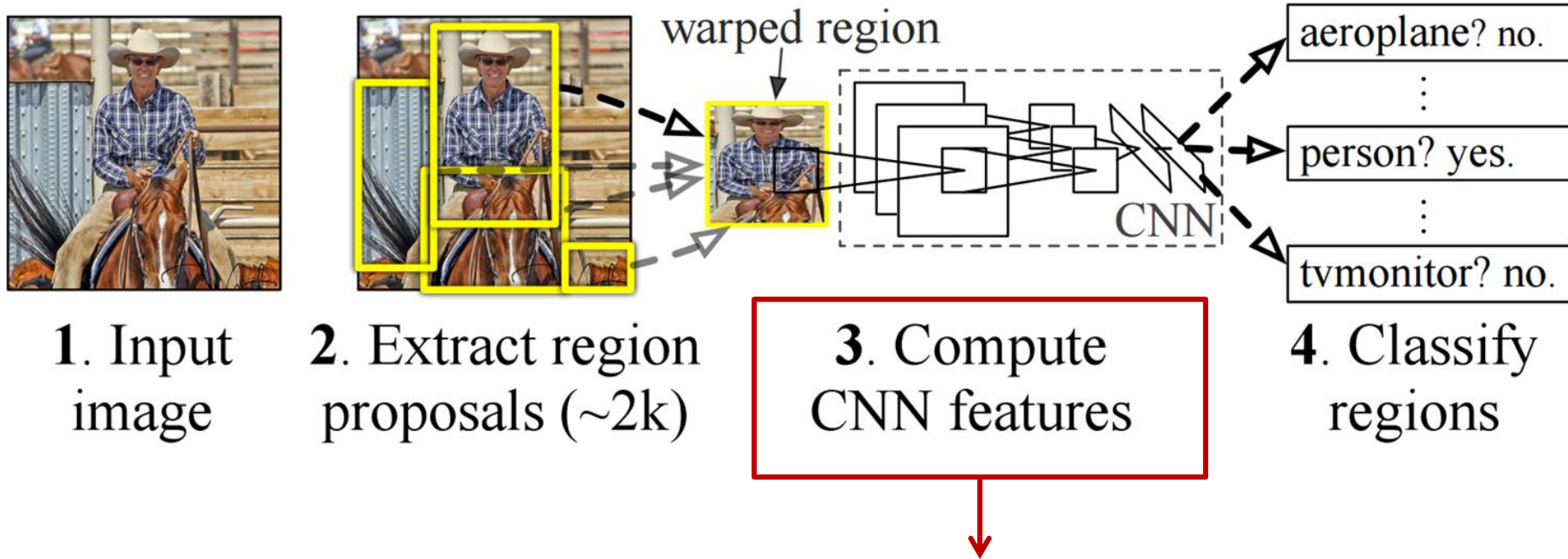

Pre-train on relative-position task, w/o labels

VOC 2007 Performance

(pretraining for R-CNN)

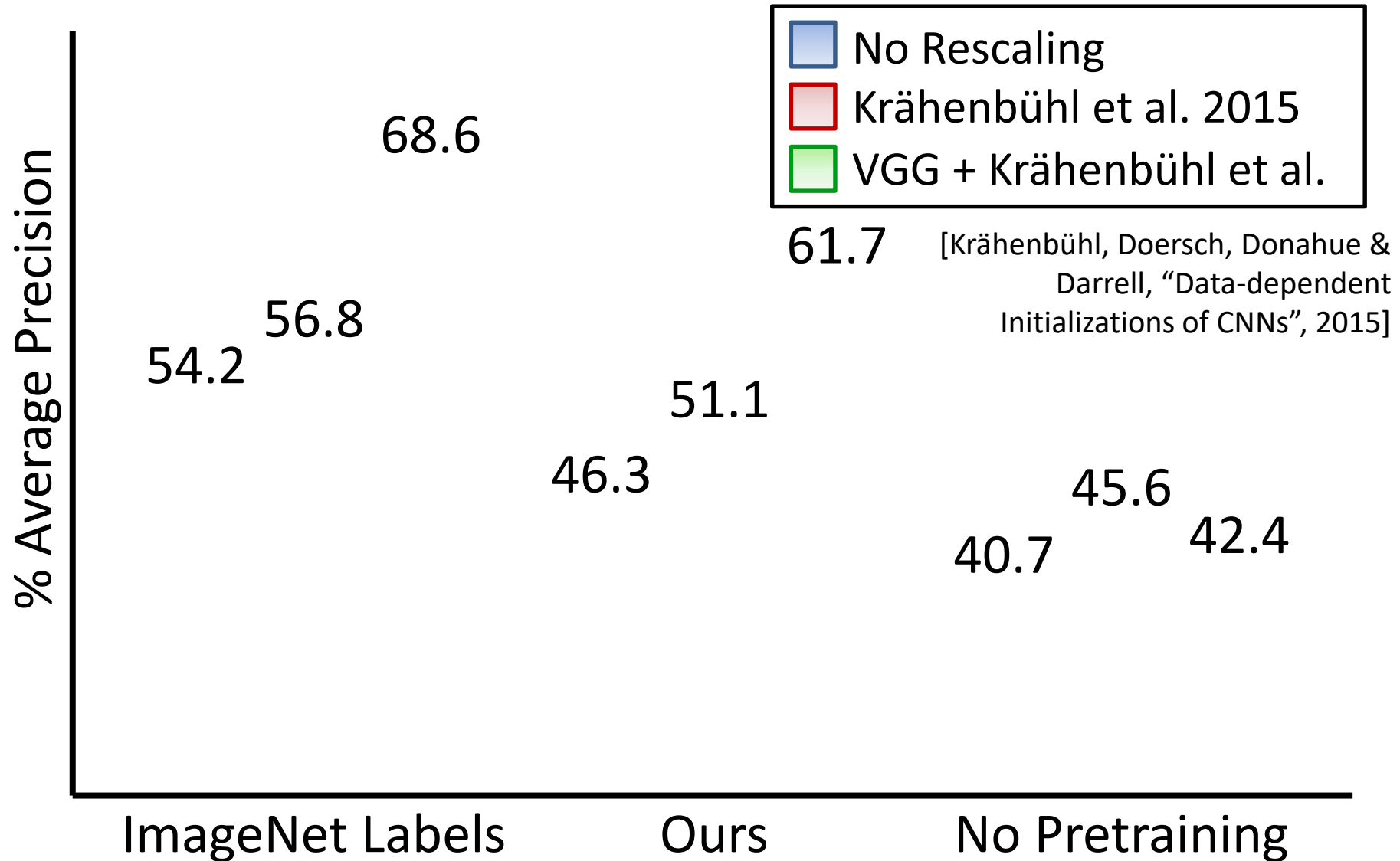

So, do we need semantic labels?

“Self-Supervision” and the Future

Ego-Motion

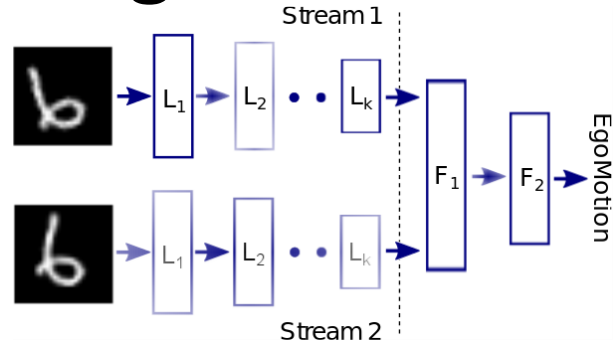

[Agrawal et al. 2015; Jayaraman et al. 2015]

Video

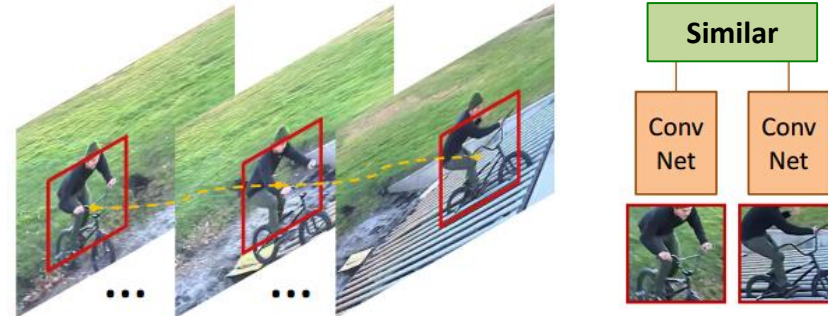

[Wang et al. 2015; Srivastava et al 2015; ...]

Context

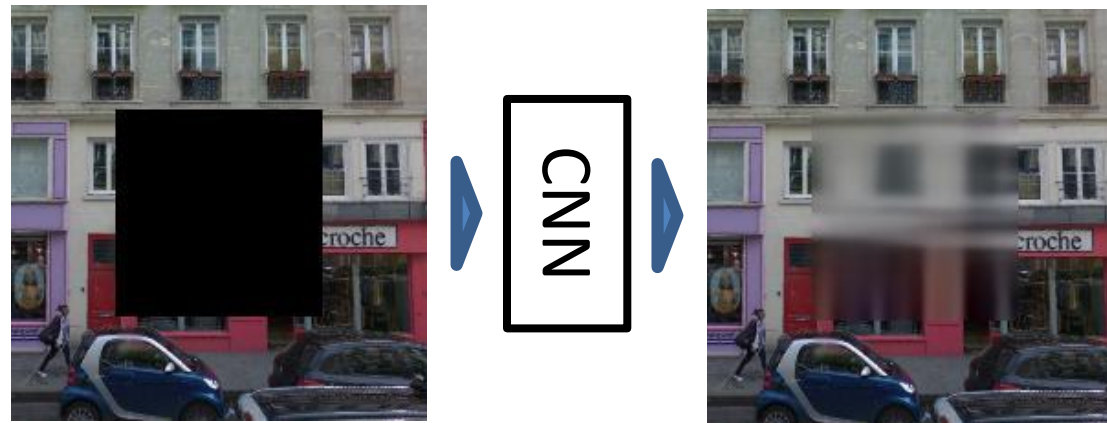

[Doersch et al. 2014; Pathak et al. 2015; Isola et al. 2015]

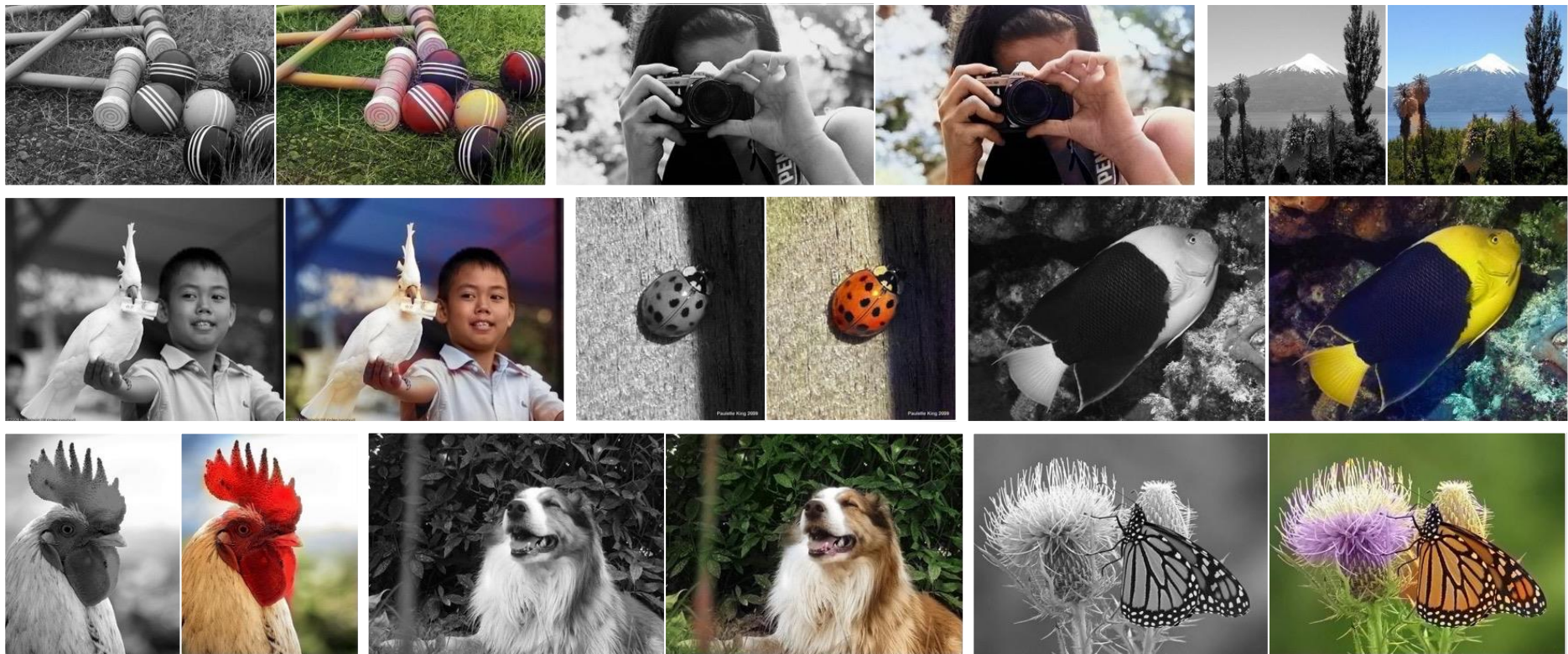

Colorful Image Colorization

Richard Zhang, Phillip Isola, Alexei (Alyosha) Efros

richzhang.github.io/colorization

ECCV 2016

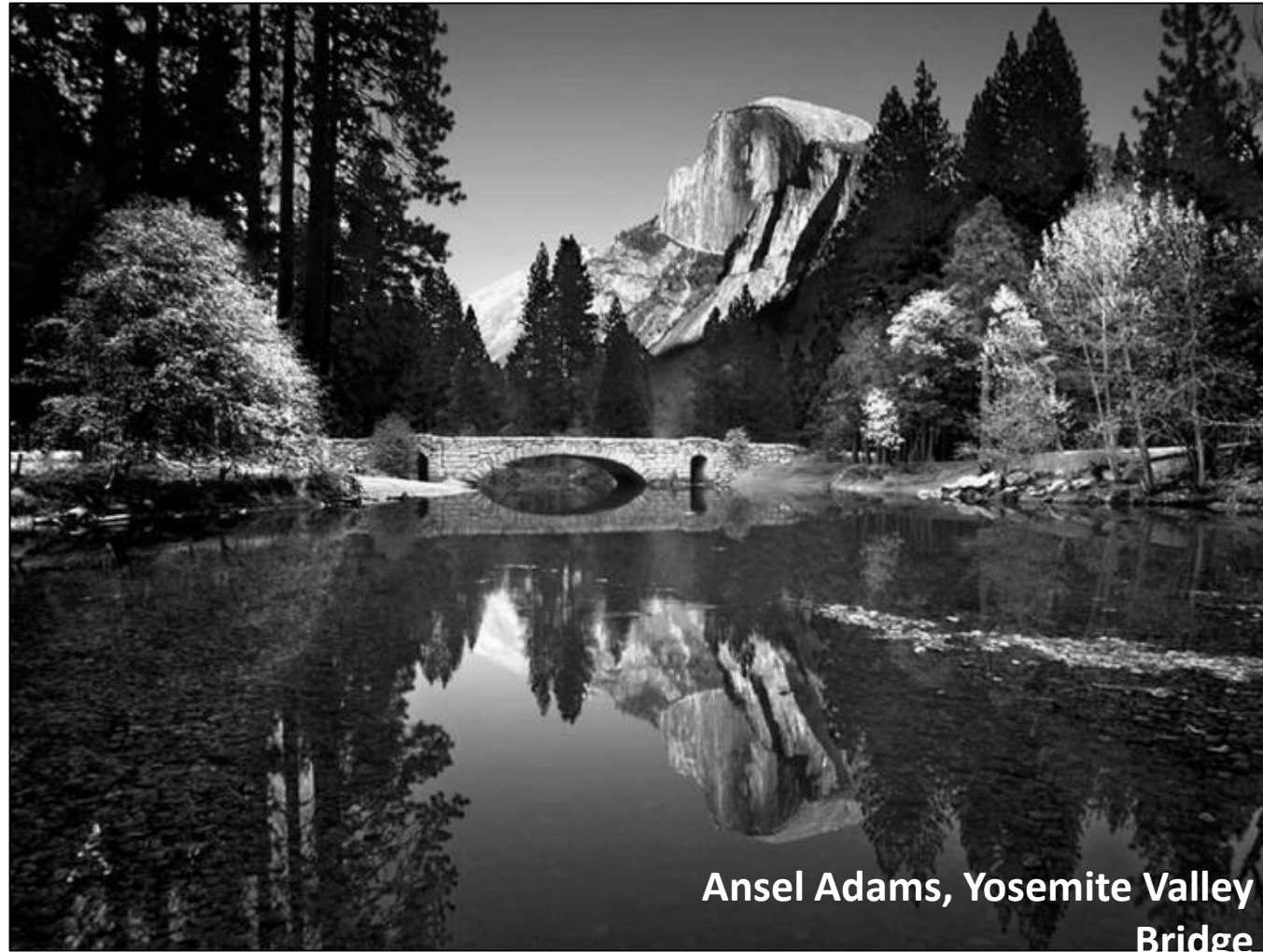

**Ansel Adams, Yosemite Valley
Bridge**



Ansel Adams, Yosemite Valley Bridge – Our Result

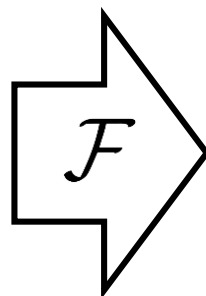
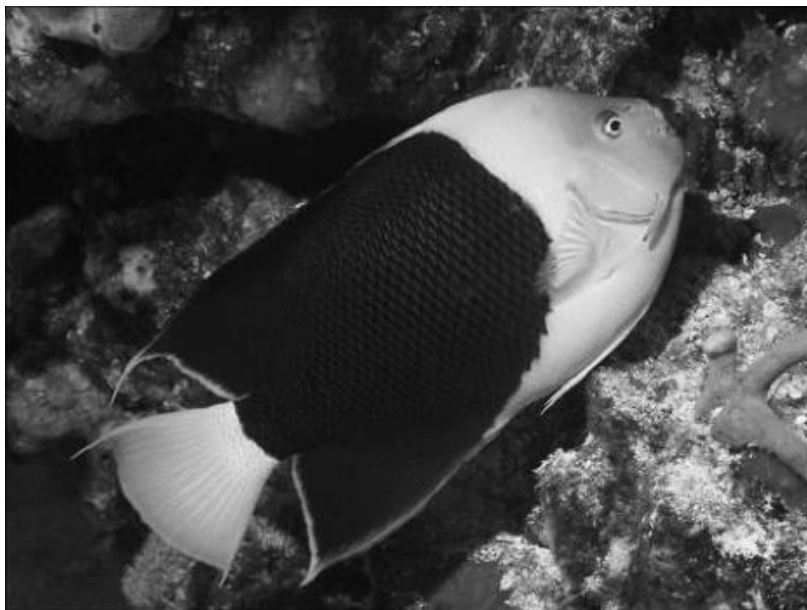

Grayscale image: L channel

$$\mathbf{X} \in \mathbb{R}^{H \times W \times 1}$$

Color information: ab channels

$$\hat{\mathbf{Y}} \in \mathbb{R}^{H \times W \times 2}$$



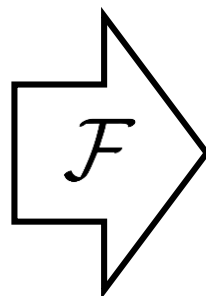
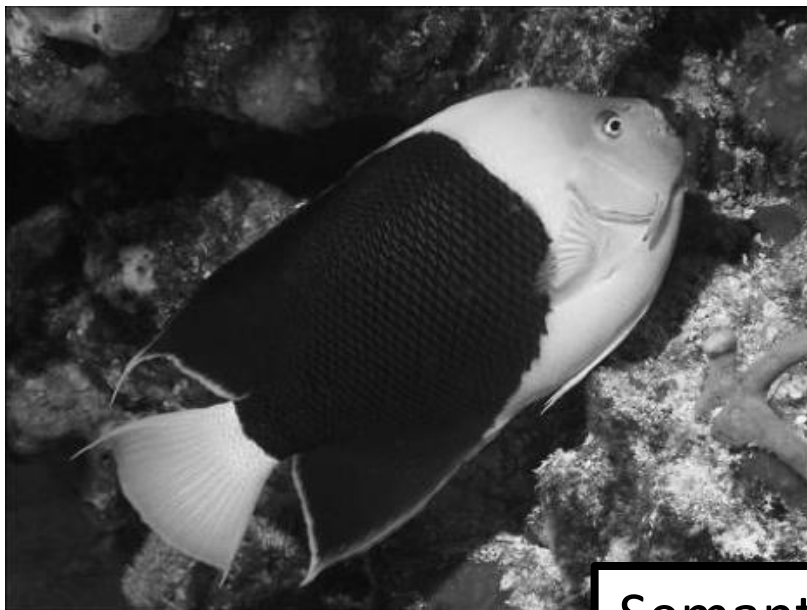

Grayscale image: L ch

$$\mathbf{X} \in \mathbb{R}^{H \times W \times L}$$

Semantics? Higher-level abstraction?

Concatenate (L, ab)

$$(\mathbf{X}, \hat{\mathbf{Y}})$$

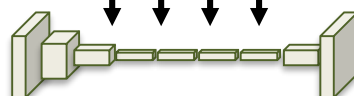

Inherent Ambiguity



Grayscale

Inherent Ambiguity



Our Output



Ground Truth

Better Loss Function

- Regression with L2 loss inadequate

$$L_2(\hat{\mathbf{Y}}, \mathbf{Y}) = \frac{1}{2} \sum_{h,w} \|\mathbf{Y}_{h,w} - \hat{\mathbf{Y}}_{h,w}\|_2^2$$

Colors in ab space

(continuous)

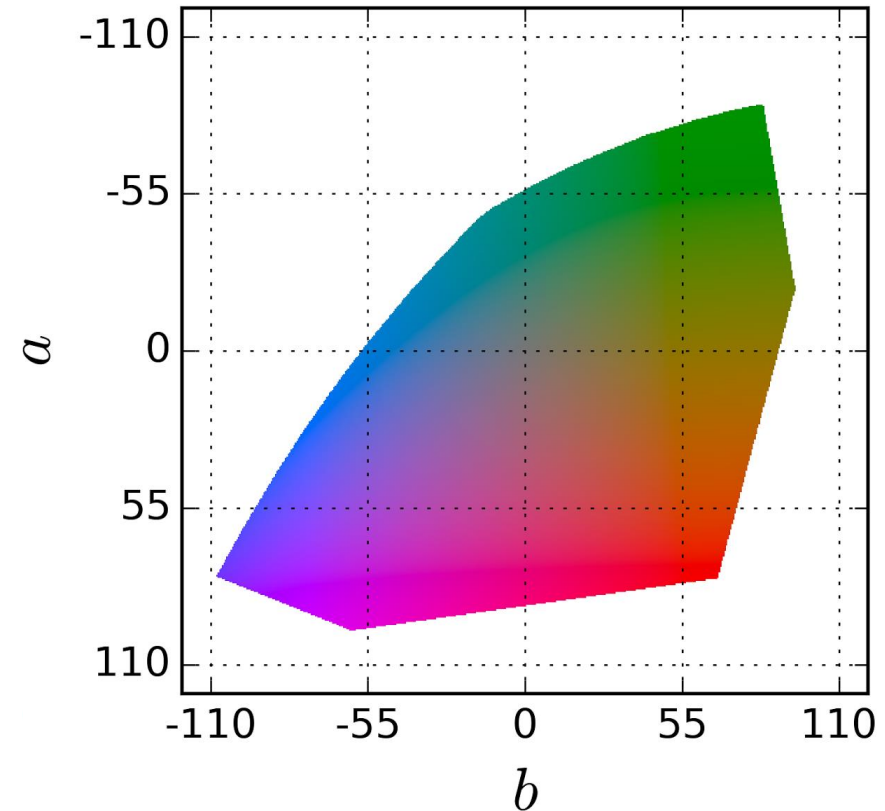

Better Loss Function

- Regression with L2 loss inadequate

$$L_2(\hat{\mathbf{Y}}, \mathbf{Y}) = \frac{1}{2} \sum_{h,w} \|\mathbf{Y}_{h,w} - \hat{\mathbf{Y}}_{h,w}\|_2^2$$

- Use **multinomial classification**

$$L(\hat{\mathbf{Z}}, \mathbf{Z}) = -\frac{1}{HW} \sum_{h,w} \sum_q \mathbf{Z}_{h,w,q} \log(\hat{\mathbf{Z}}_{h,w,q})$$

Colors in *ab* space
(discrete)

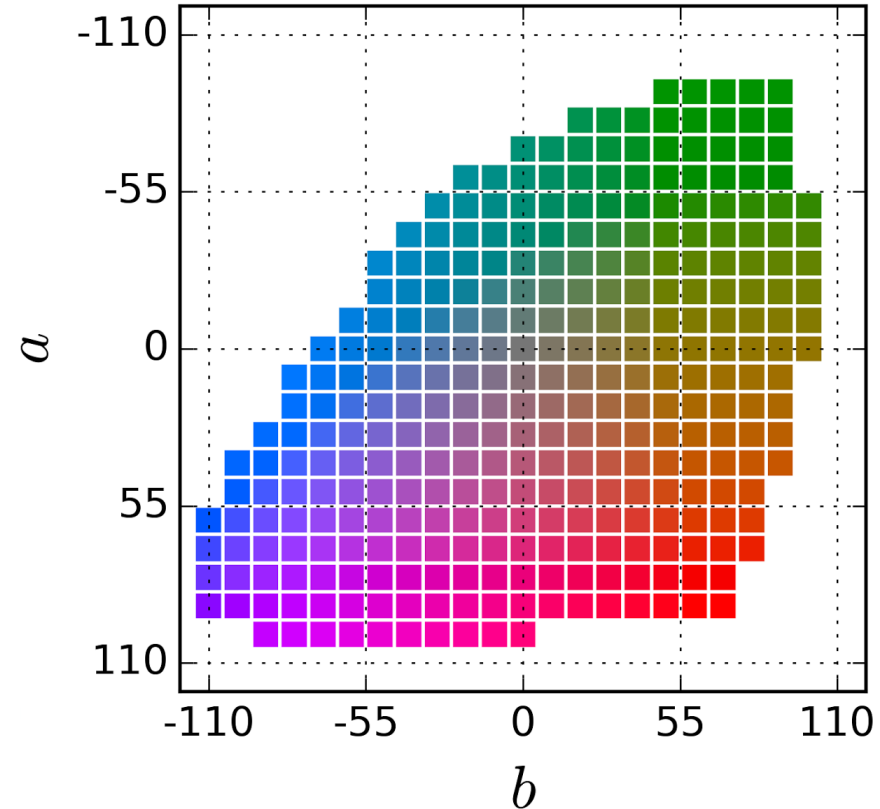

Better Loss Function

- Regression with L2 loss inadequate

$$L_2(\hat{\mathbf{Y}}, \mathbf{Y}) = \frac{1}{2} \sum_{h,w} \|\mathbf{Y}_{h,w} - \hat{\mathbf{Y}}_{h,w}\|_2^2$$

- Use **multinomial classification**

$$L(\hat{\mathbf{Z}}, \mathbf{Z}) = -\frac{1}{HW} \sum_{h,w} \sum_q \mathbf{Z}_{h,w,q} \log(\hat{\mathbf{Z}}_{h,w,q})$$

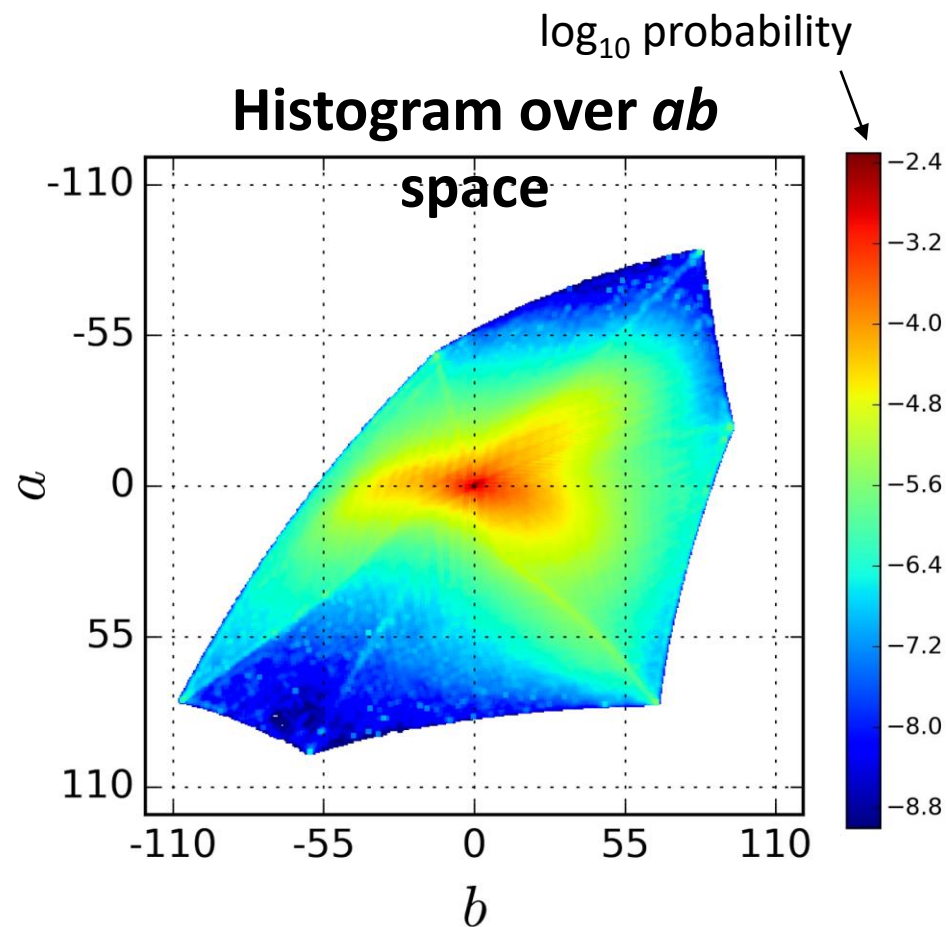

Better Loss Function

- Regression with L2 loss inadequate

$$L_2(\hat{\mathbf{Y}}, \mathbf{Y}) = \frac{1}{2} \sum_{h,w} \|\mathbf{Y}_{h,w} - \hat{\mathbf{Y}}_{h,w}\|_2^2$$

- Use **multinomial classification**

$$L(\hat{\mathbf{Z}}, \mathbf{Z}) = -\frac{1}{HW} \sum_{h,w} \sum_q \mathbf{Z}_{h,w,q} \log(\hat{\mathbf{Z}}_{h,w,q})$$

- **Class rebalancing** to encourage learning of *rare* colors

$$L(\hat{\mathbf{Z}}, \mathbf{Z}) = -\frac{1}{HW} \sum_{h,w} v(\mathbf{Z}_{h,w}) \sum_q \mathbf{Z}_{h,w,q} \log(\hat{\mathbf{Z}}_{h,w,q})$$

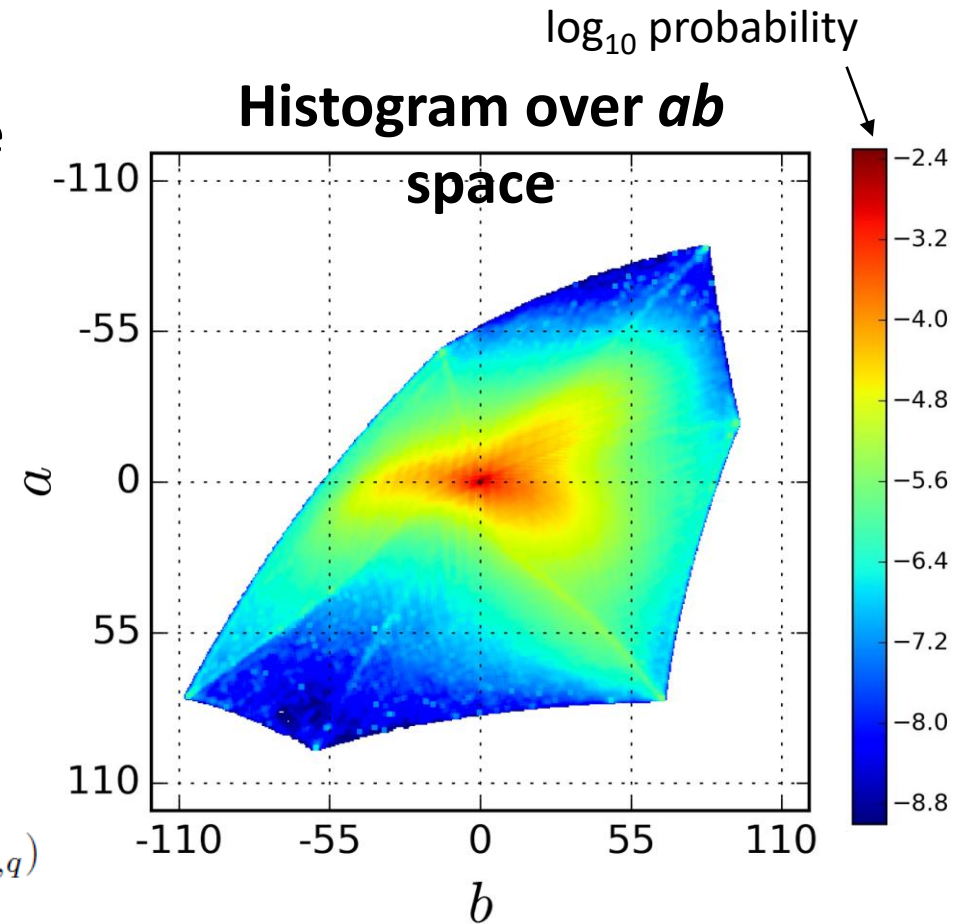

Non-parametric

Hertzmann et al. In SIGGRAPH, 2001.
 Welsh et al. In TOG, 2002.
 Irony et al. In Eurographics, 2005.
 Liu et al. In TOG, 2008.
 Chia et al. In ACM 2011.
 Gupta et al. In ACM, 2012.

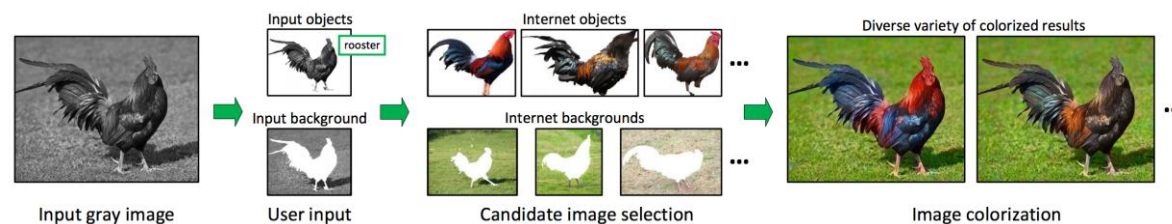

Parametric

L2 Regression

Hand-engineered Features

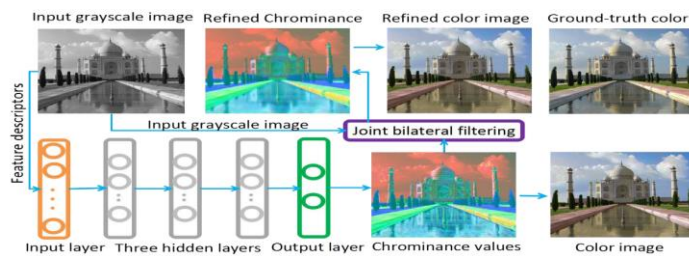

Deshpande et al. Cheng et al. In ICCV 2015.

Classification

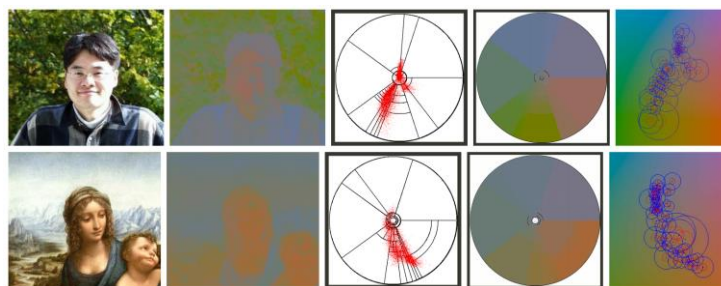

Charpiat et al. In ECCV 2008.

Deep Networks

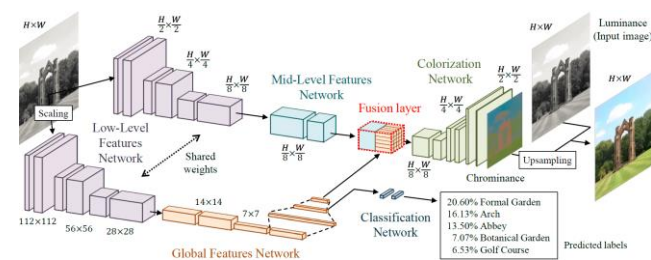

Dahl. Jan 2016. Iizuka et al. In SIGGRAPH, 2016.

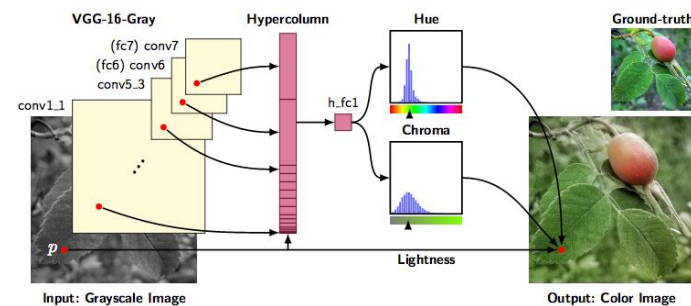

Larsson et al. In ECCV 2016. [Concurrent]

Network Architecture

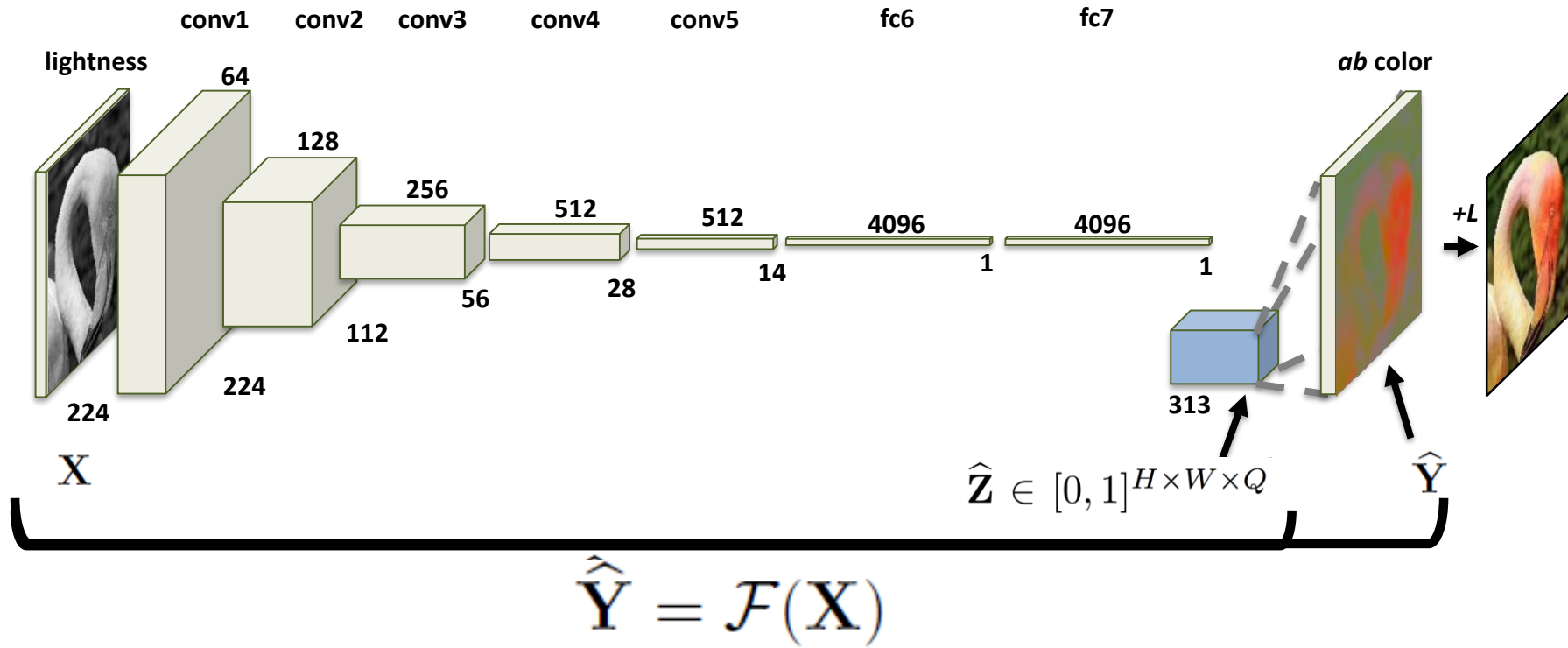

Network Architecture

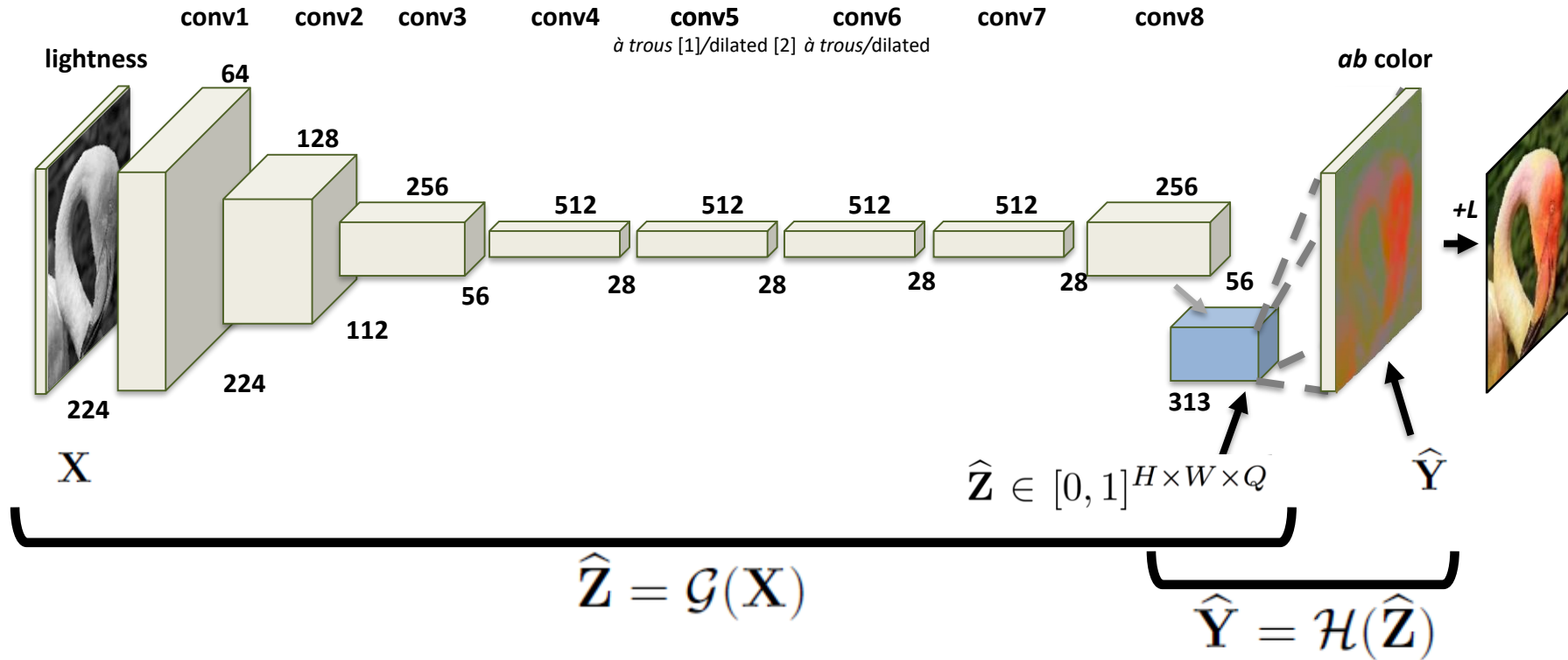

[1] Chen *et al.* In arXiv, 2016.
 [2] Yu and Koltun. In ICLR, 2016

Ground Truth



L2 Regression



Class w/ Rebalancing



Biases



Evaluation

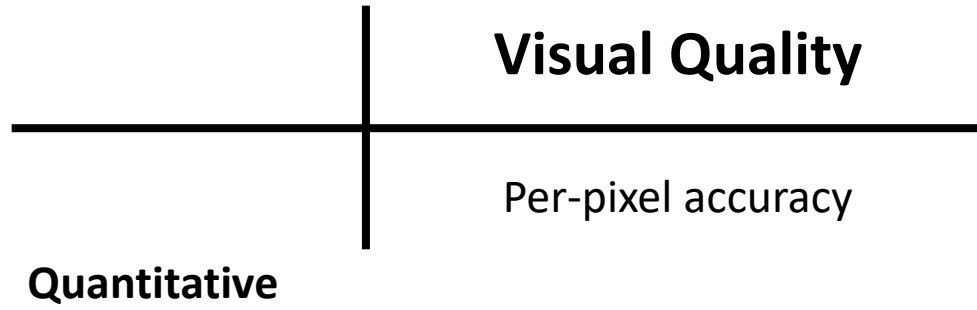

Evaluation

	Visual Quality	Representation Learning
Quantitative	<p>Per-pixel accuracy</p> <p>Perceptual realism</p> <p>Semantic interpretability</p>	<p>Task generalization ImageNet classification</p> <p>Task & dataset generalization PASCAL classification, detection, segmentation</p>
Qualitative	<p>Low-level stimuli</p> <p>Legacy grayscale photos</p>	<p>Hidden unit activations</p>

Evaluation

	Visual Quality	Representation Learning
Quantitative	<p>Per-pixel accuracy</p> <p>Perceptual realism</p> <p>Semantic interpretability</p>	<p>Task generalization ImageNet classification</p> <p>Task & dataset generalization PASCAL classification, detection, segmentation</p>
Qualitative	<p>Low-level stimuli</p> <p>Legacy grayscale photos</p>	<p>Hidden unit activations</p>

Perceptual Realism / Amazon Mechanical Turk Test



Fake, 0% fooled



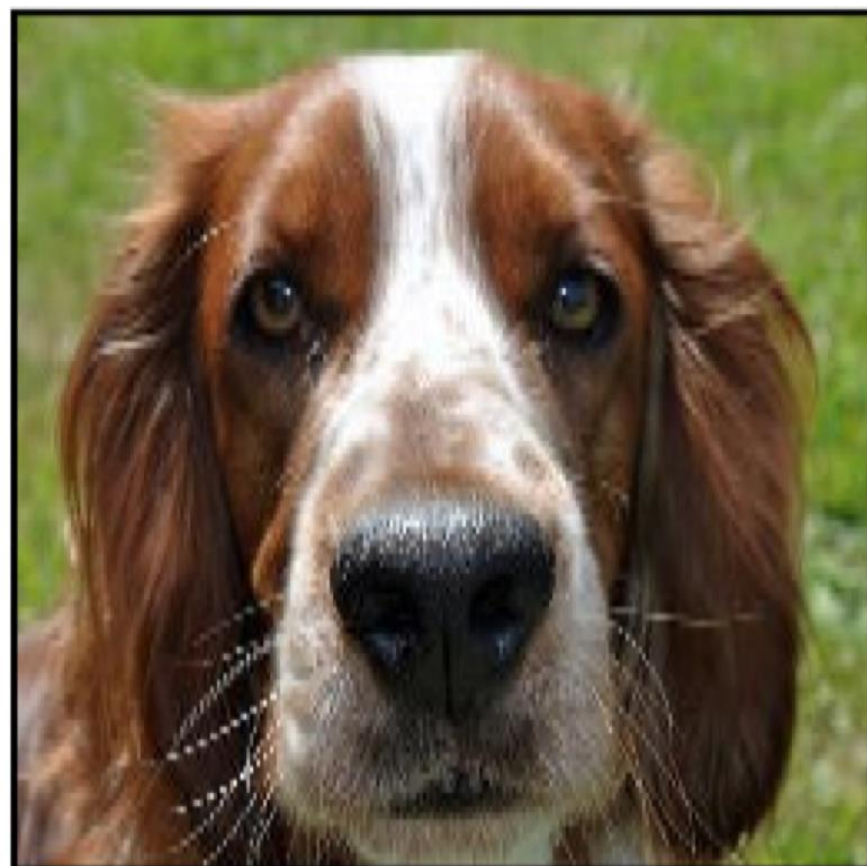

Fake, 55% fooled

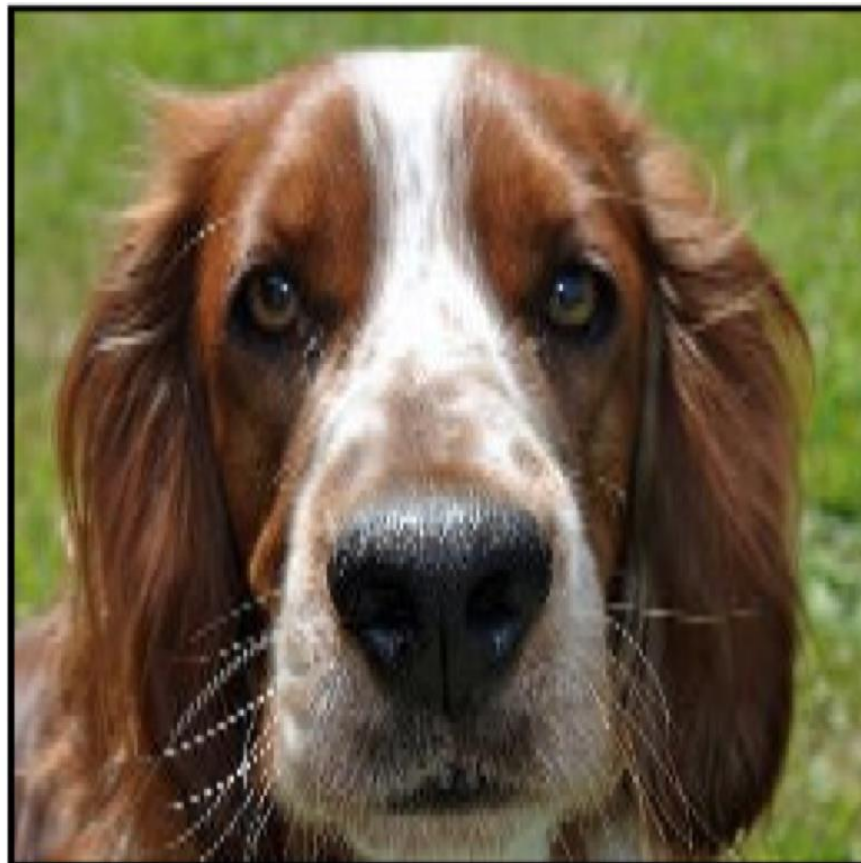



Fake, 58% fooled





from Reddit /u/SherySantucci



Recolorized by Reddit ColorizeBot

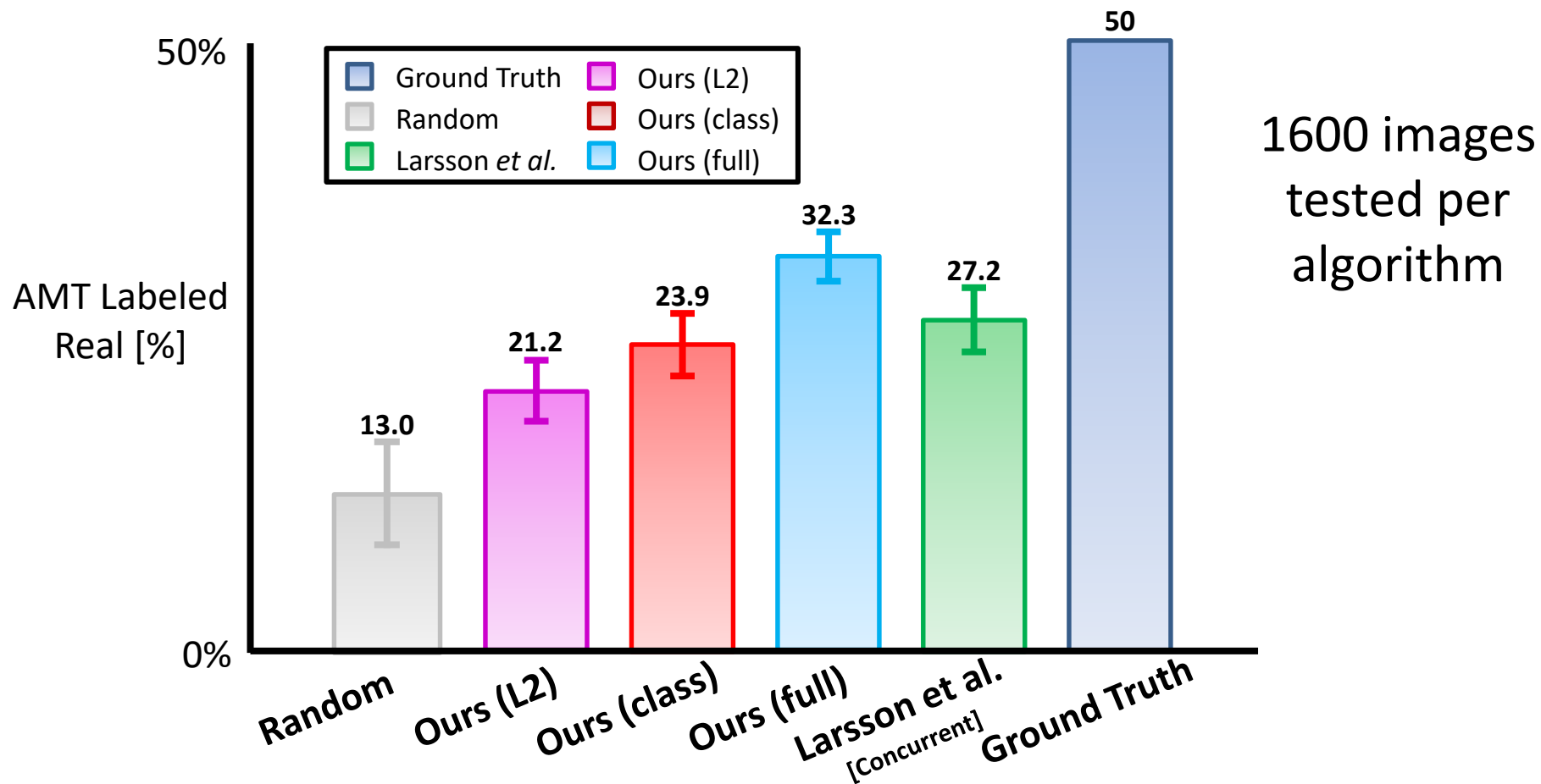

**Photo taken by
Reddit /u/Timteroo,
Mural from street
artist Eduardo Kobra**



**Recolorized
by Reddit
ColorizeBot**

Perceptual Realism Test



Input



Ground Truth



Output

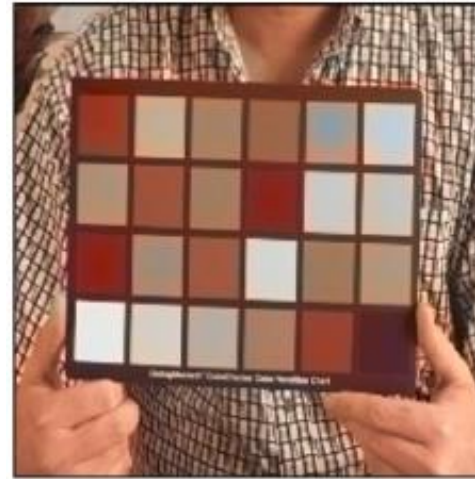
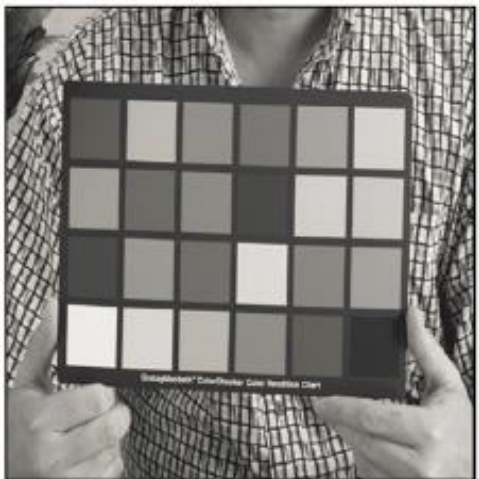

Predicting Labels from Data

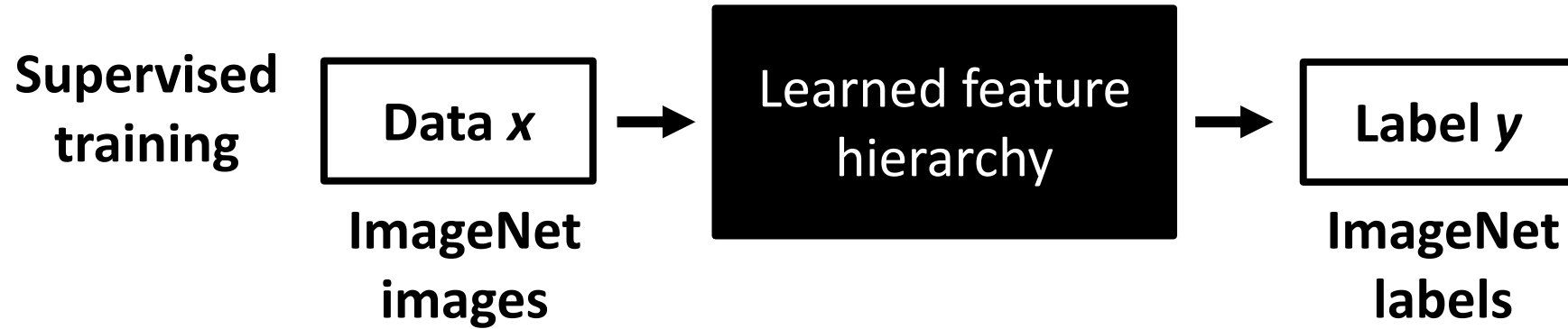

Predicting Data from Data

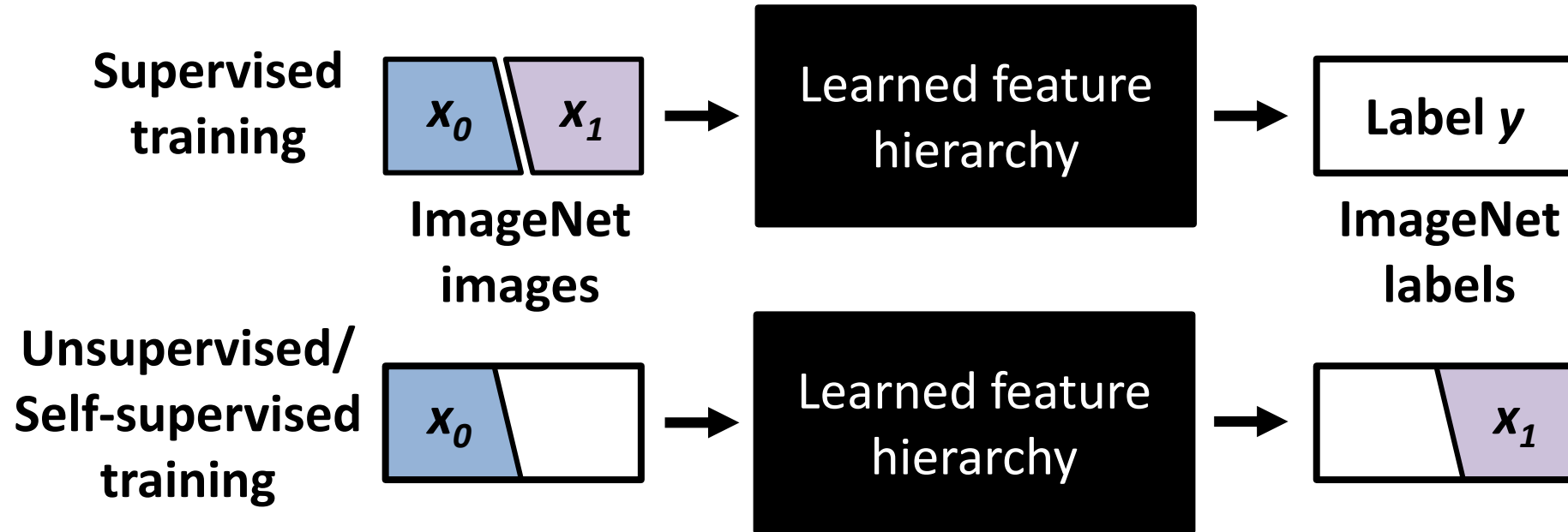

Autoencoders

Hinton & Salakhutdinov.
Science 2006.

Denosing Autoencoders

Vincent *et al.* ICML 2008.

Audio

Owens *et al.* CVPR 2016, ECCV 2016

Co-Occurrence

Isola *et al.* ICLR Workshop 2016.

Egomotion

Agrawal *et al.* ICCV 2015

Jayaraman *et al.* ICCV 2015

Context

Doersch *et al.* ICCV 2015

Pathak *et al.* CVPR 2016

Video

Wang *et al.* ICCV 2015

Task Generalization: ILSVRC linear classification

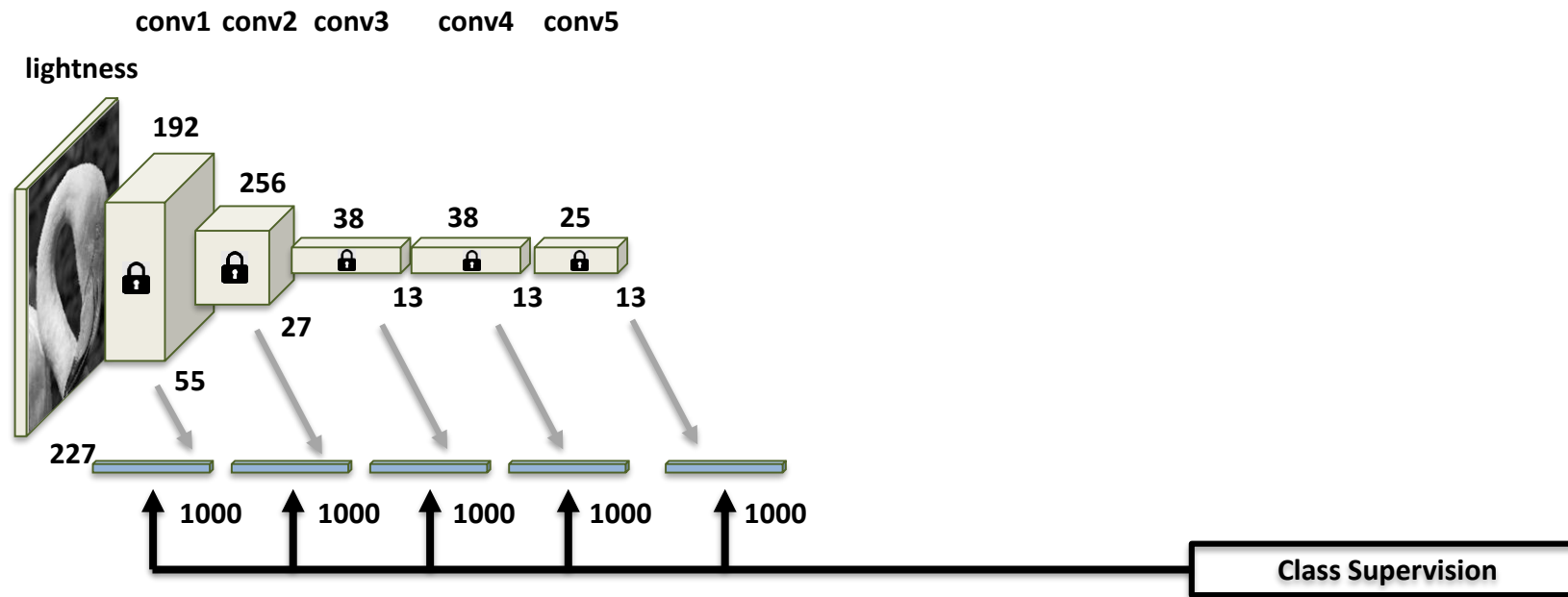

Are semantic classes *linearly separable* in the learned feature space?

Task Generalization: ILSVRC linear classification

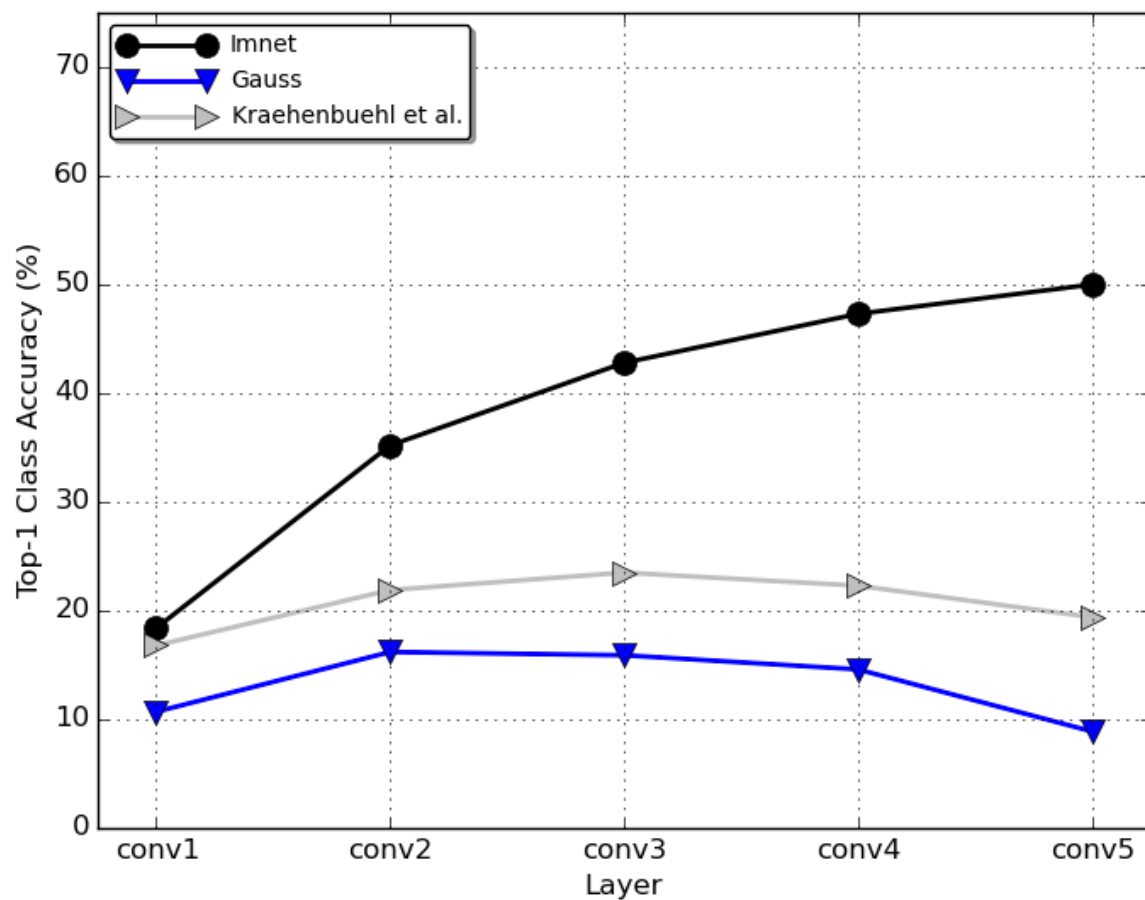

Task Generalization: ILSVRC linear classification

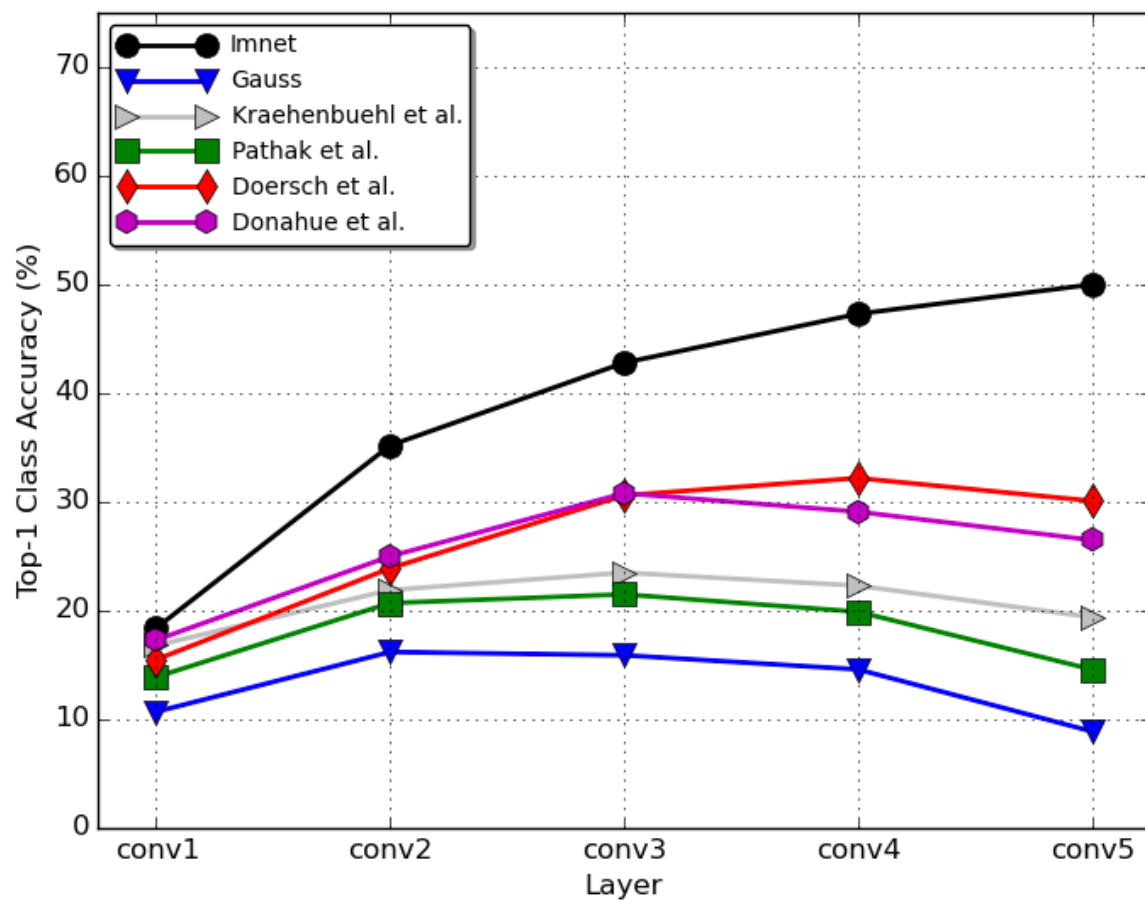

Task Generalization: ILSVRC linear classification

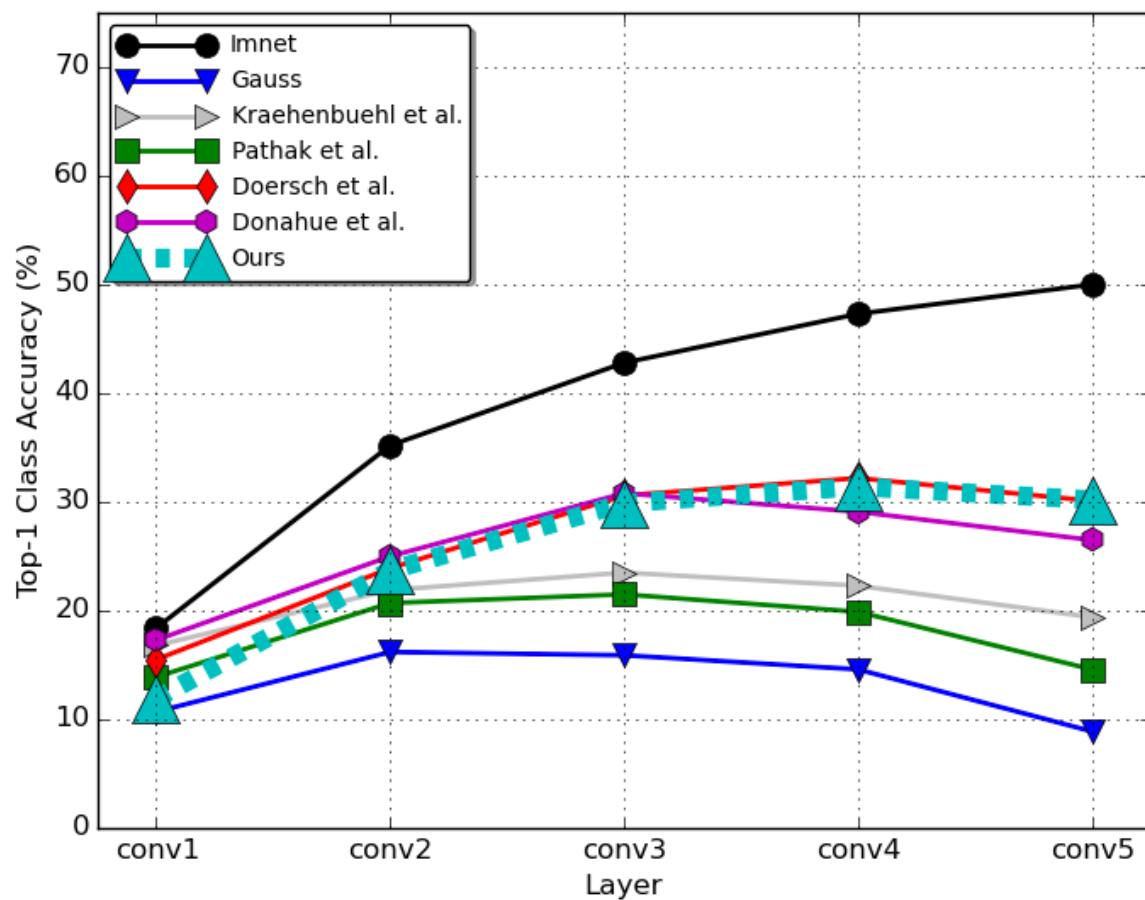

Hidden Unit (conv5) Activations

sky



trees

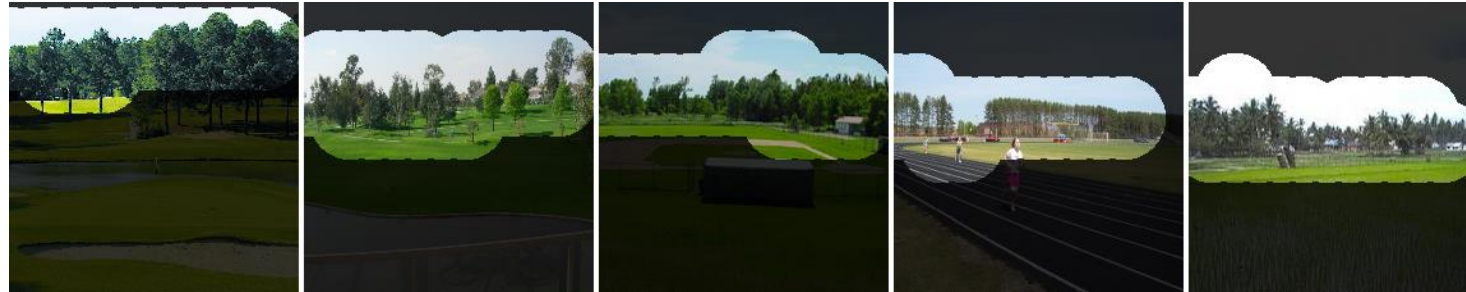

water

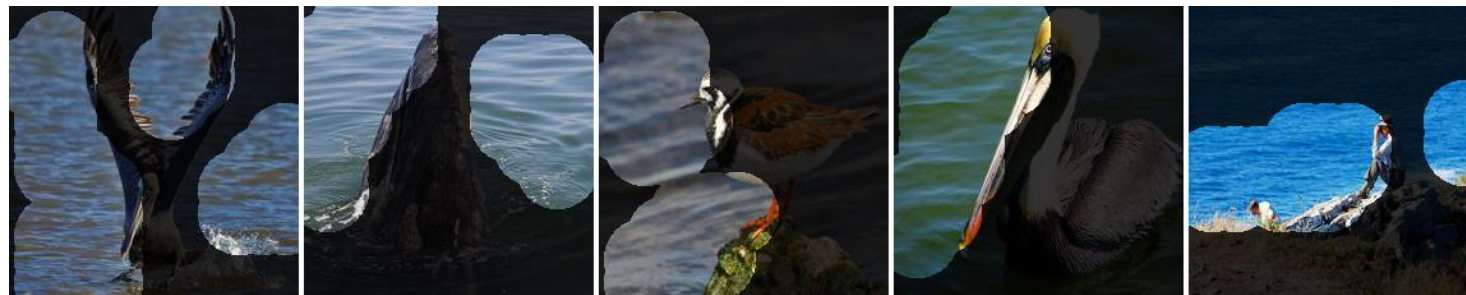

Hidden Unit (conv5) Activations

faces



dog
faces

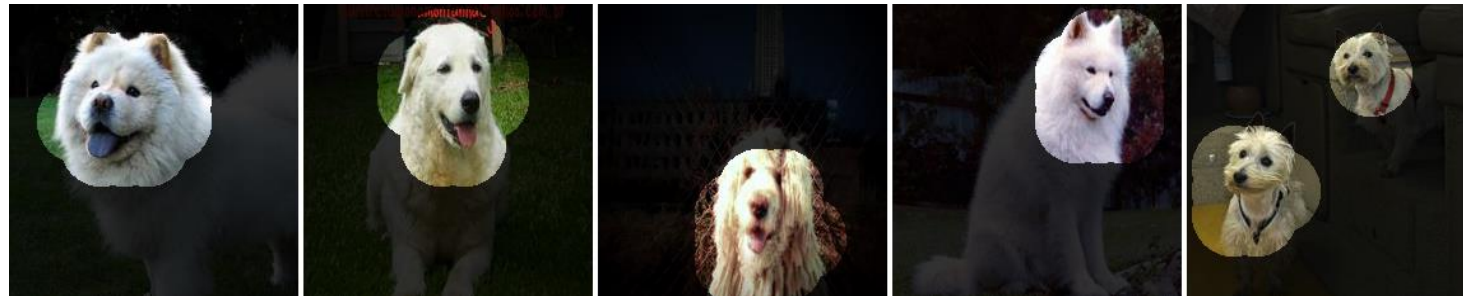

flowers

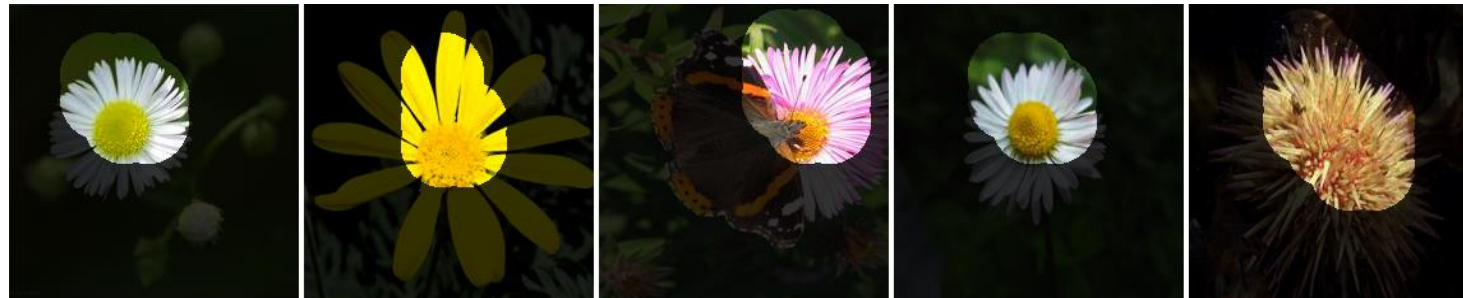

Dataset & Task Generalization on PASCAL VOC

Does the feature representation *transfer* to other datasets and tasks?

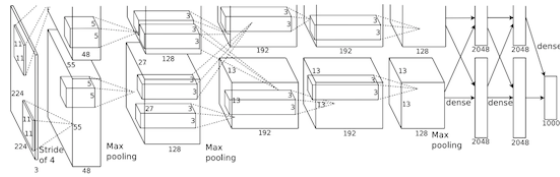

Classification

Krähenbühl et al. In ICLR, 2016.

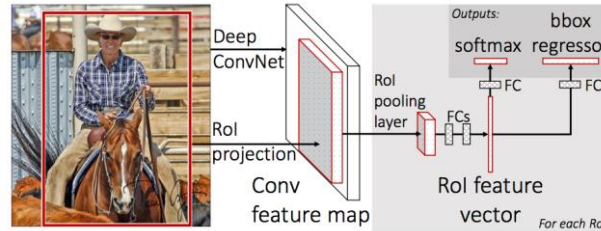

Detection

Fast R-CNN. Girshick. In ICCV, 2015.

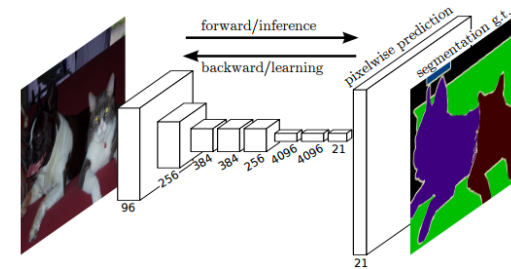

Segmentation

FCNs. Long et al. In CVPR, 2015.

Does the method
work on *legacy* black
and white photos?

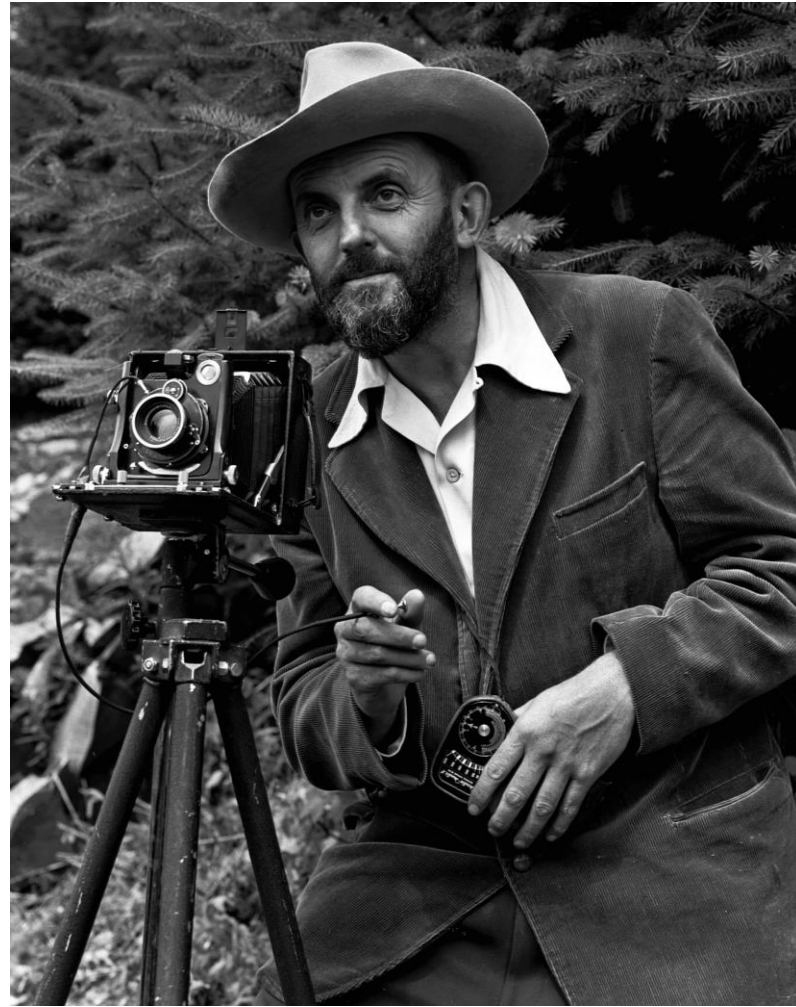

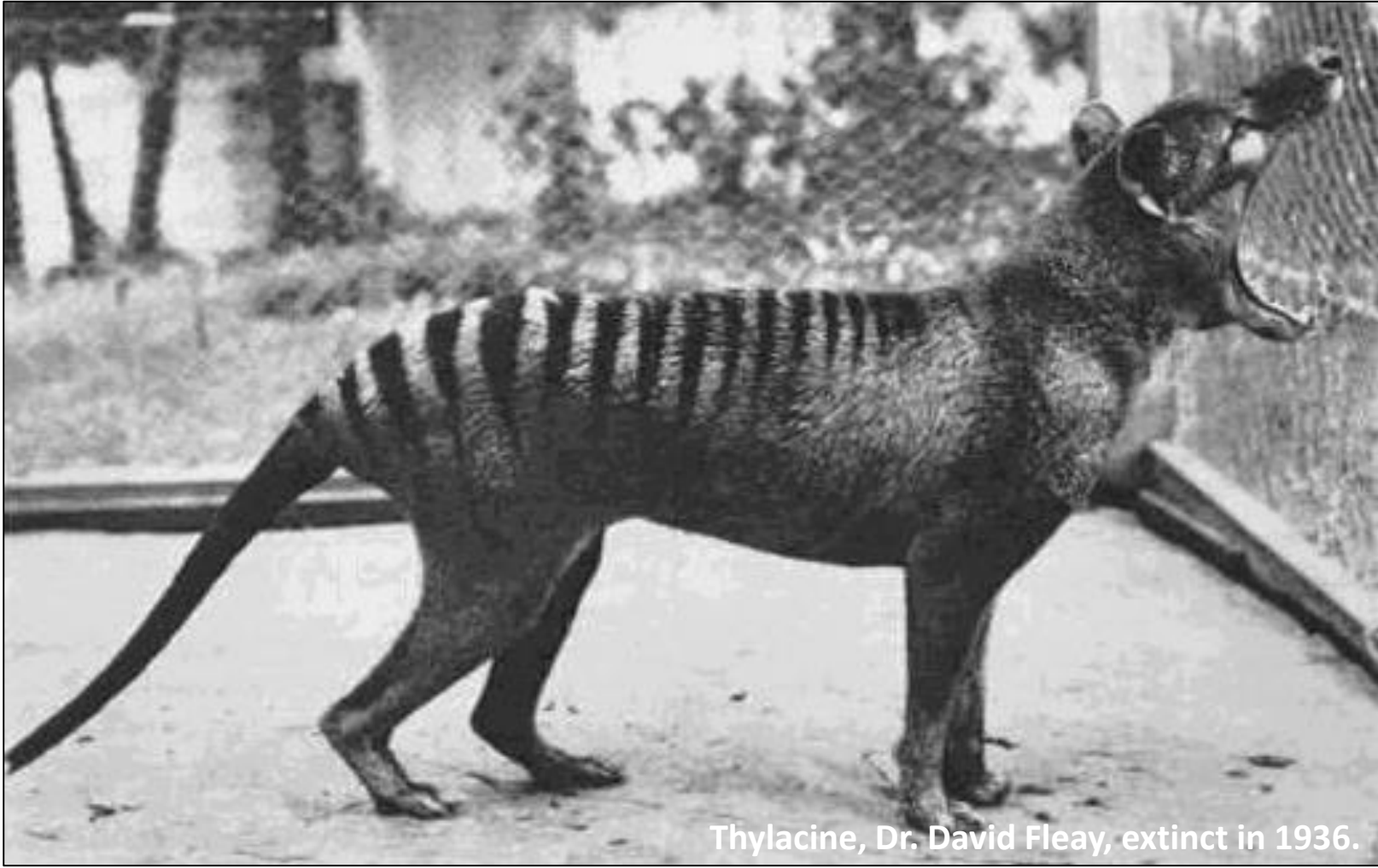

Thylacine, Dr. David Fleay, extinct in 1936.



Thylacine, Dr. David Fleay, extinct in 1936.



Amateur Family Photo,
1956



Amateur Family Photo,
1956

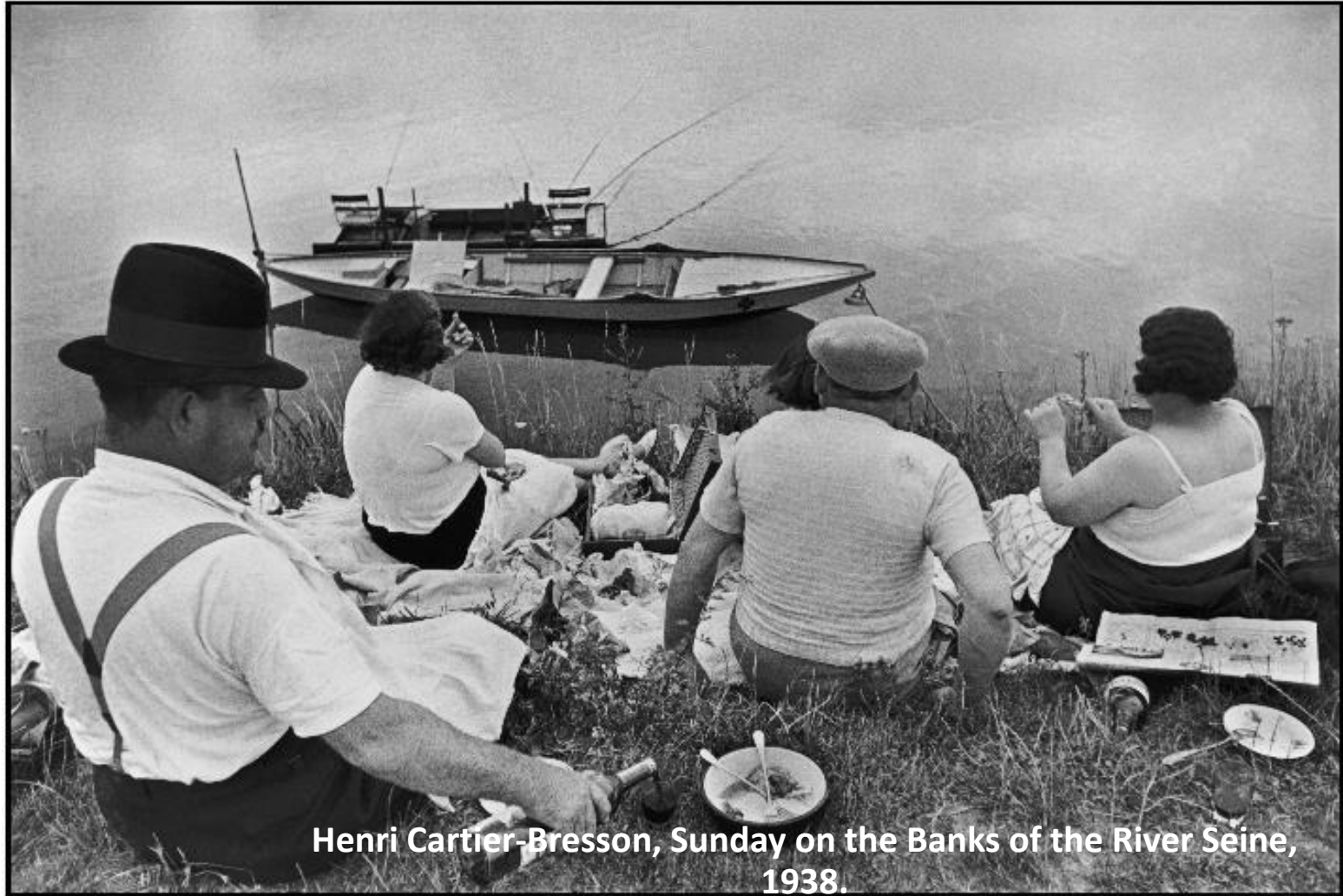

Henri Cartier-Bresson, Sunday on the Banks of the River Seine, 1938.



Henri Cartier-Bresson, Sunday on the Banks of the River Seine, 1938.

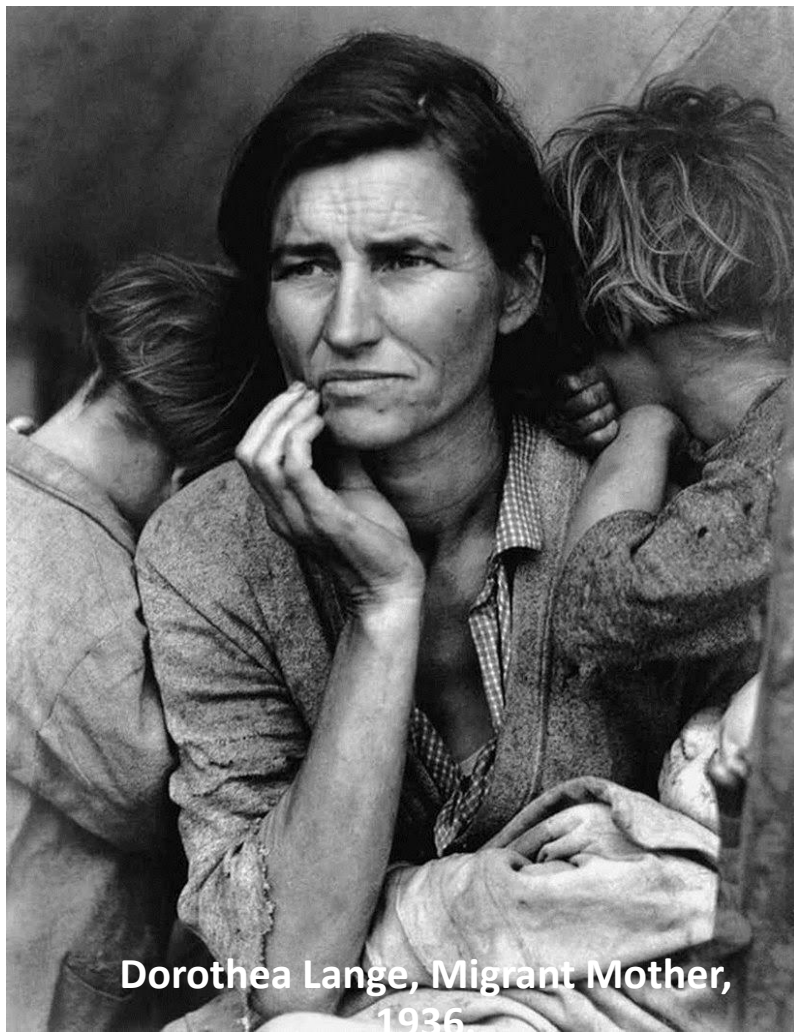

Dorothea Lange, Migrant Mother,
1936

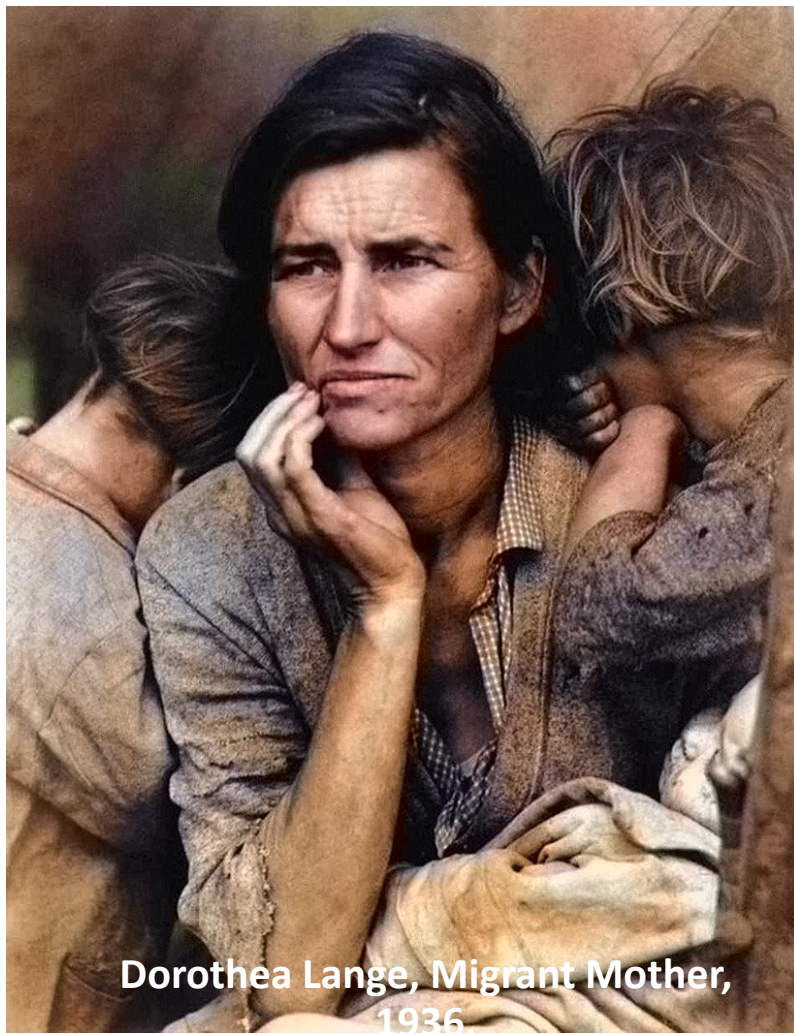

Dorothea Lange, Migrant Mother, 1936

Additional Information

- Demo
 - <http://demos.algorithmia.com/colorize-photos/>
- Reddit ColorizeBot
 - Type “colorizebot” under any image post
- Code
 - <https://github.com/richzhang/colorization>
- Website – full paper, user examples, visualizations
 - <http://richzhang.github.io/colorization>

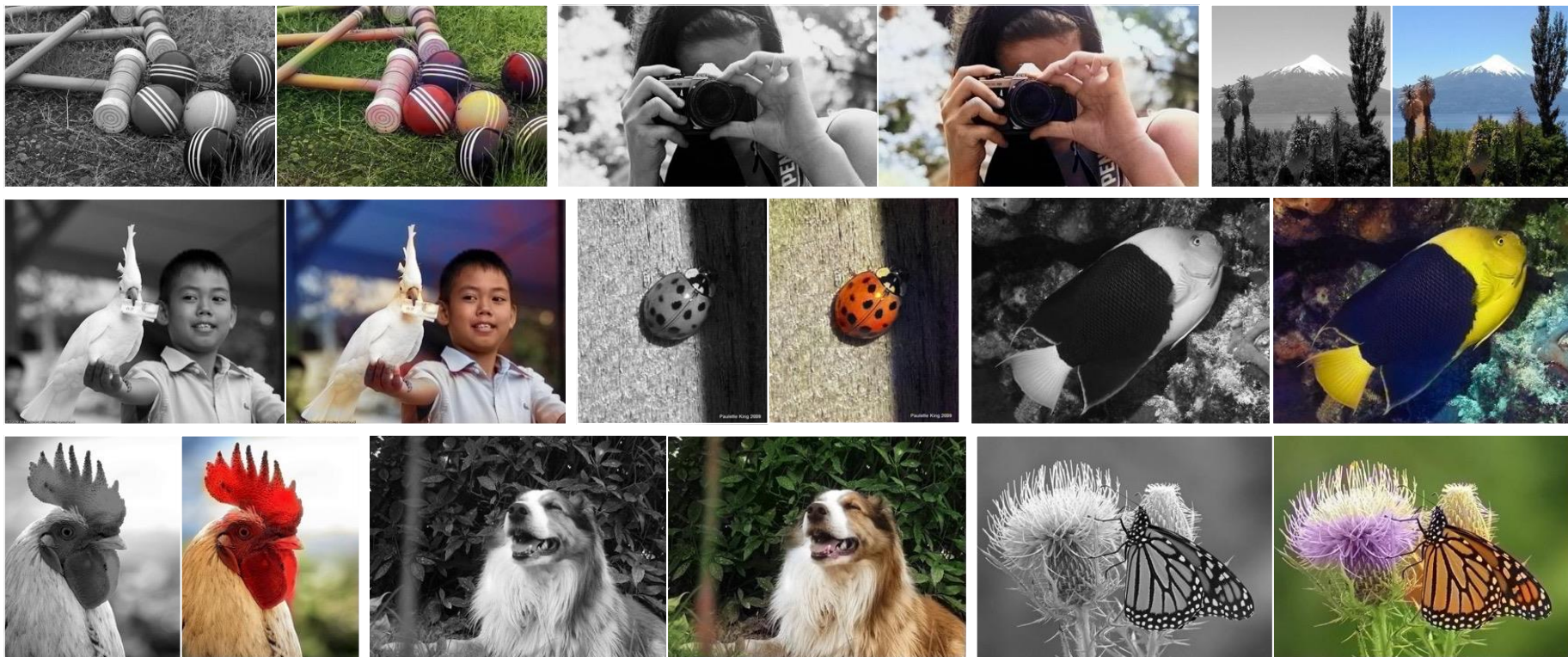

For the full paper, additional examples and our model:
richzhang.github.io/colorization

The Gelato Bet, Resolved

"If, by the first day of autumn (Sept 23) of 2015, a method will exist that can match or beat the performance of R-CNN on Pascal VOC detection, without the use of any extra, human annotations (e.g. ImageNet) as pre-training, Mr. Malik promises to buy Mr. Efros one (1) gelato"



Dataset & Task Generalization on PASCAL VOC

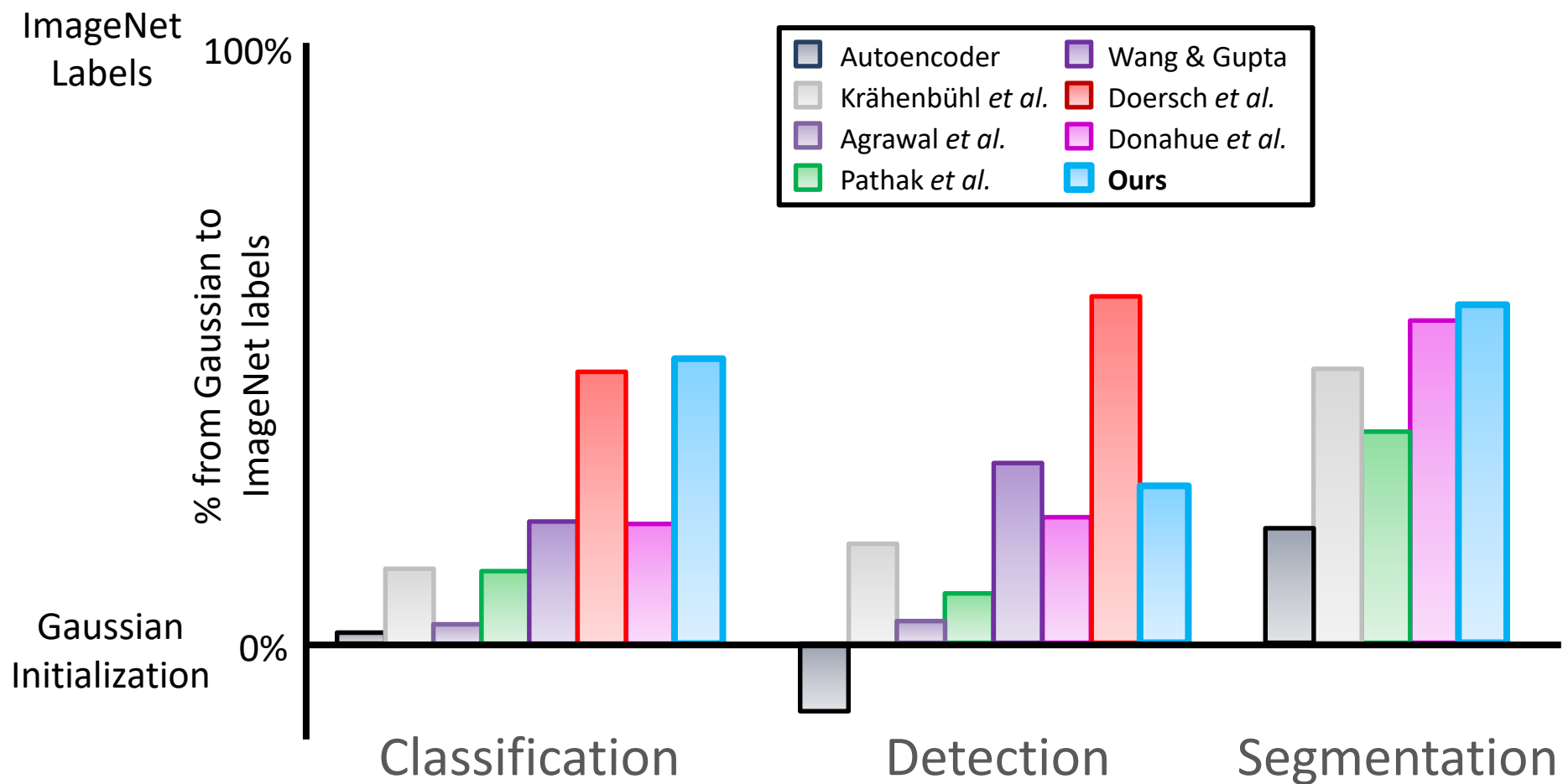

A Simple Framework for Contrastive Learning of Visual Representations

Ting Chen¹ Simon Kornblith¹ Mohammad Norouzi¹ Geoffrey Hinton¹

SimCLR, IMCL 2020

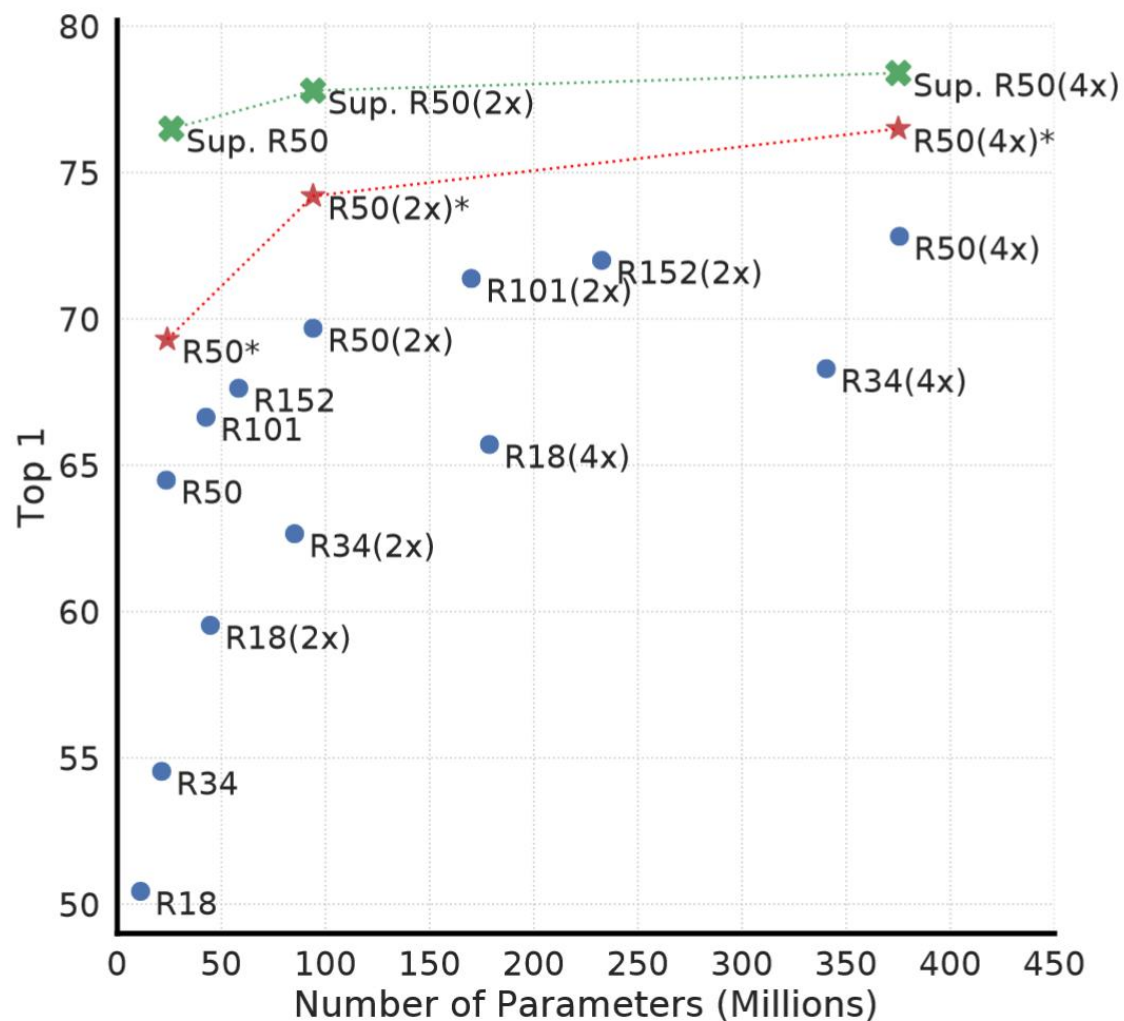
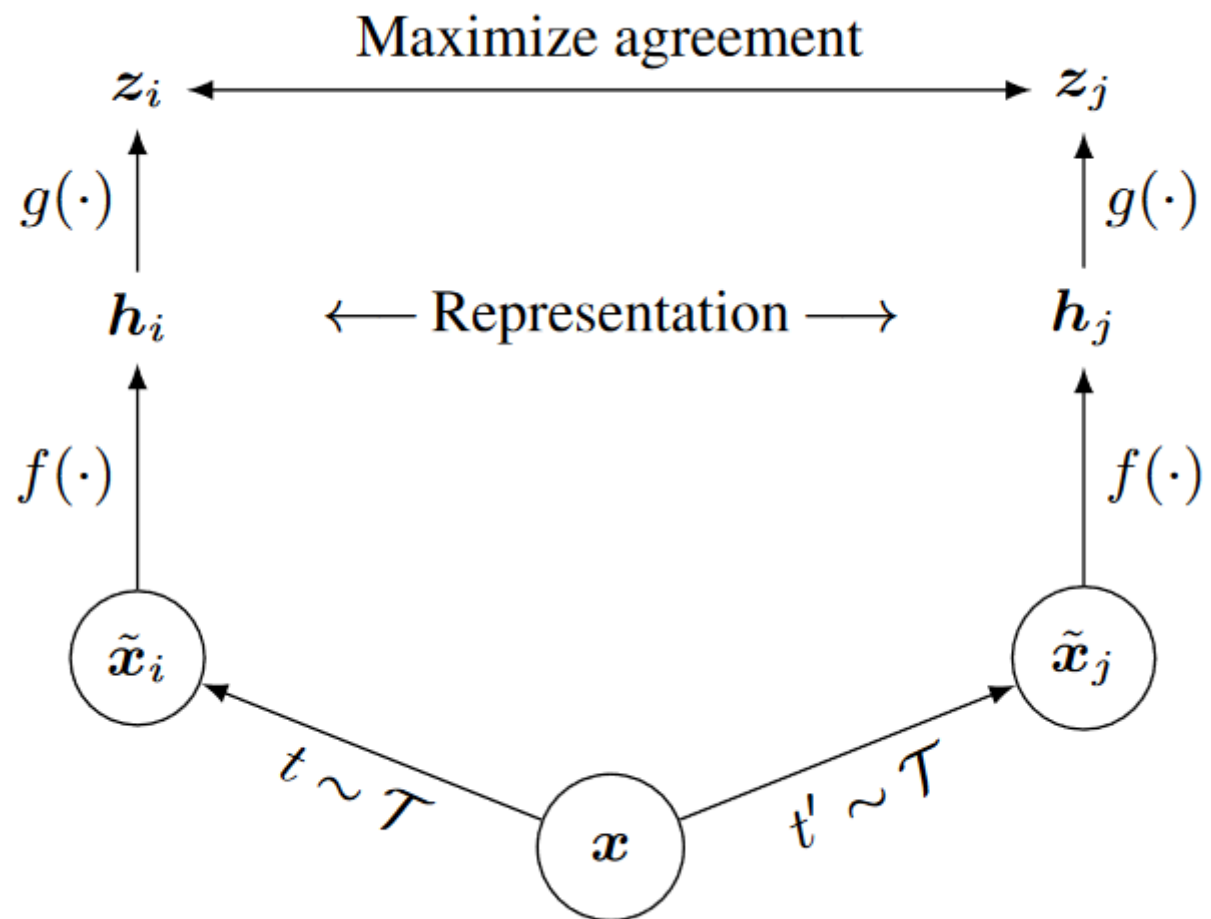

Figure 7. Linear evaluation of models with varied depth and width. Models in blue dots are ours trained for 100 epochs, models in red stars are ours trained for 1000 epochs, and models in green crosses are supervised ResNets trained for 90 epochs⁷ (He et al., 2016).





(a) Original



(b) Crop and resize



(c) Crop, resize (and flip)



(d) Color distort. (drop)



(e) Color distort. (jitter)



(f) Rotate $\{90^\circ, 180^\circ, 270^\circ\}$



(g) Cutout



(h) Gaussian noise



(i) Gaussian blur

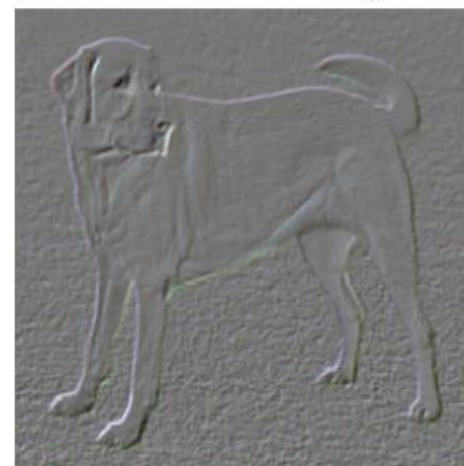

(j) Sobel filtering

Masked Autoencoders Are Scalable Vision Learners

Kaiming He^{*,†} Xinlei Chen^{*} Saining Xie Yanghao Li Piotr Dollár Ross Girshick

^{*}equal technical contribution [†]project lead

Facebook AI Research (FAIR)

CVPR 2022

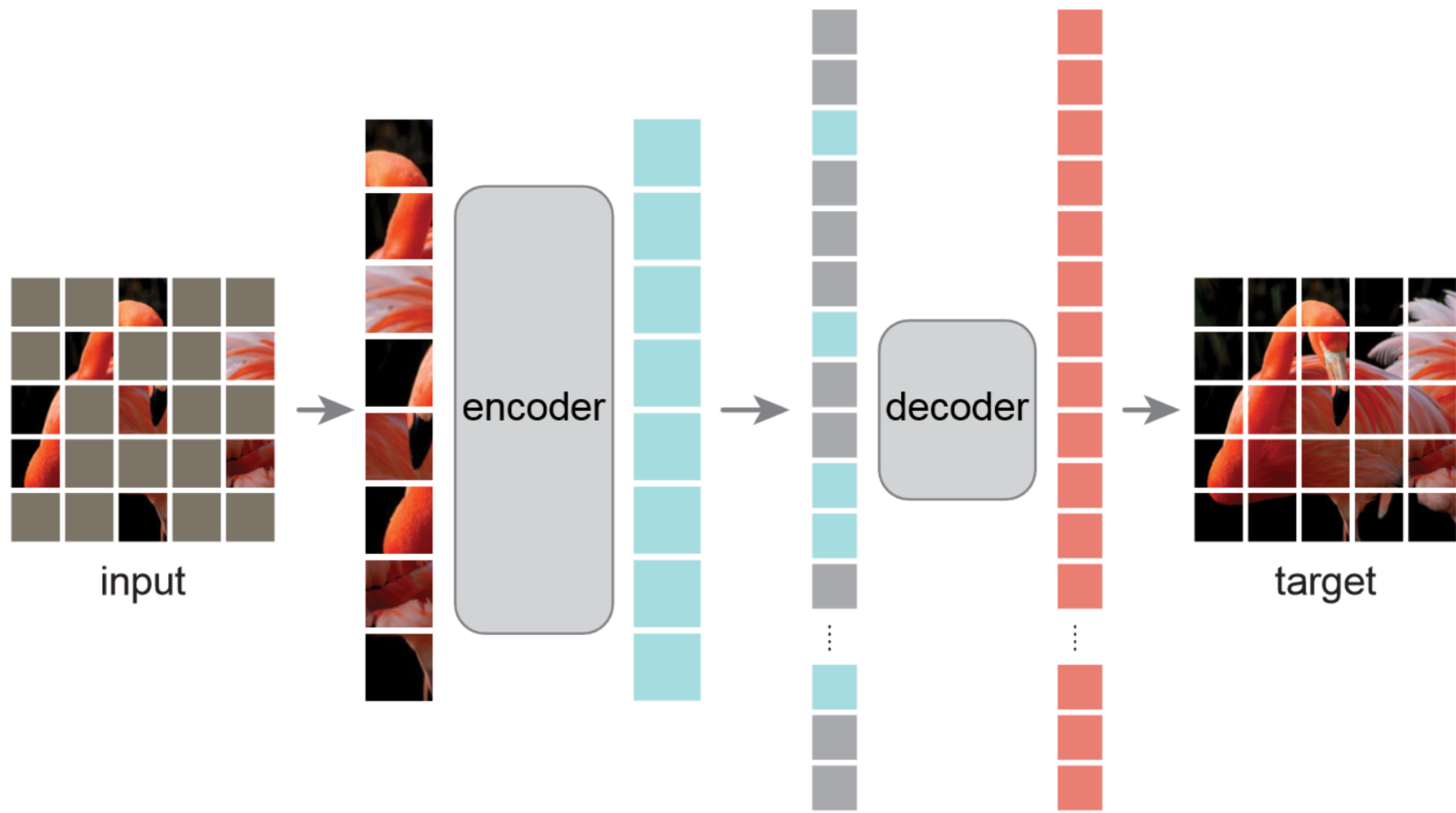

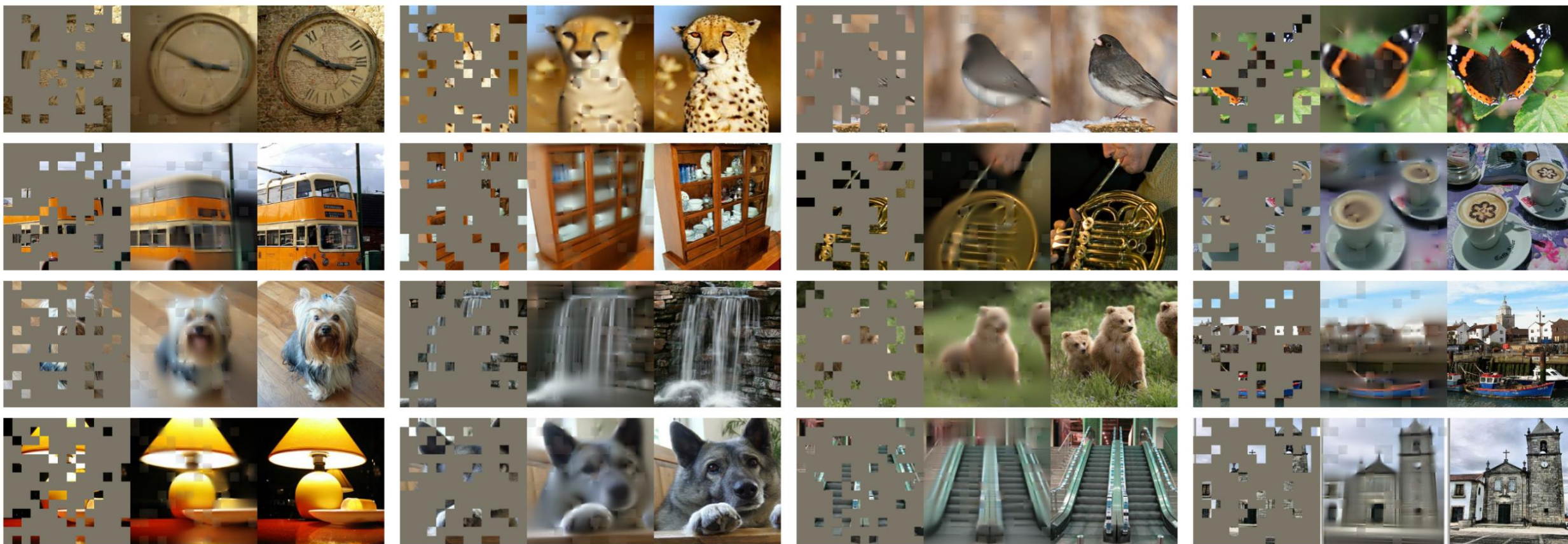

Figure 2. Example results on ImageNet *validation* images. For each triplet, we show the masked image (left), our MAE reconstruction[†] (middle), and the ground-truth (right). The masking ratio is 80%, leaving only 39 out of 196 patches. More examples are in the appendix.
[†]As no loss is computed on visible patches, the model output on visible patches is qualitatively worse. One can simply overlay the output with the visible patches to improve visual quality. We intentionally opt not to do this, so we can more comprehensively demonstrate the method’s behavior.



Figure 3. Example results on COCO validation images, using an MAE trained on ImageNet (the same model weights as in Figure 2). Observe the reconstructions on the two right-most examples, which, although different from the ground truth, are semantically plausible.

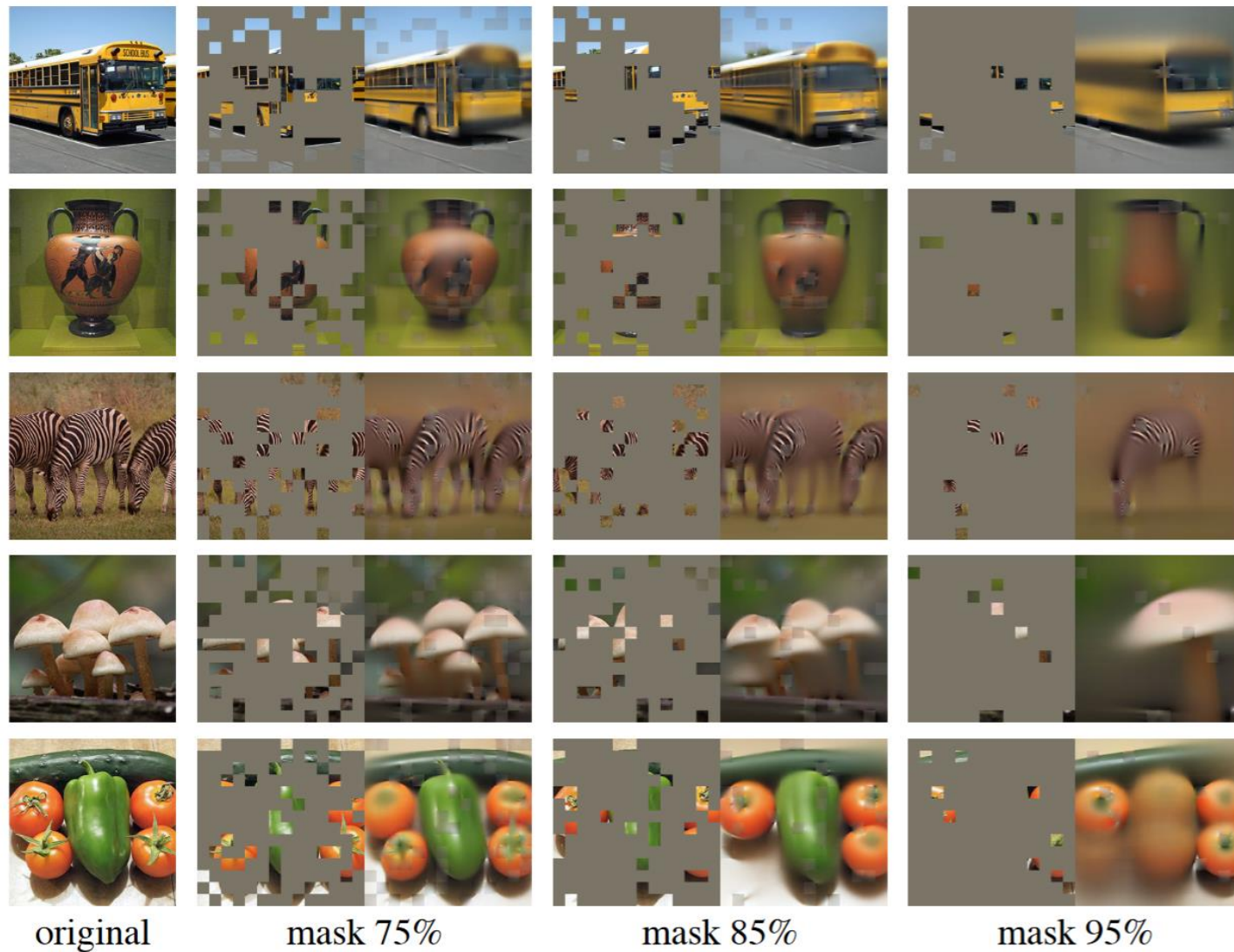
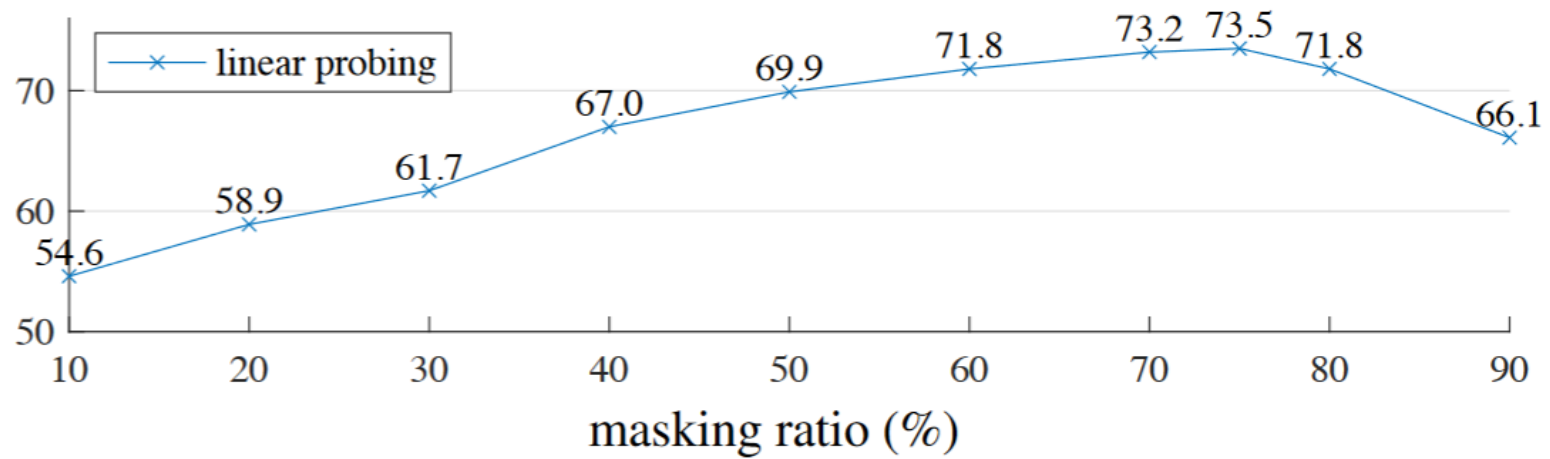
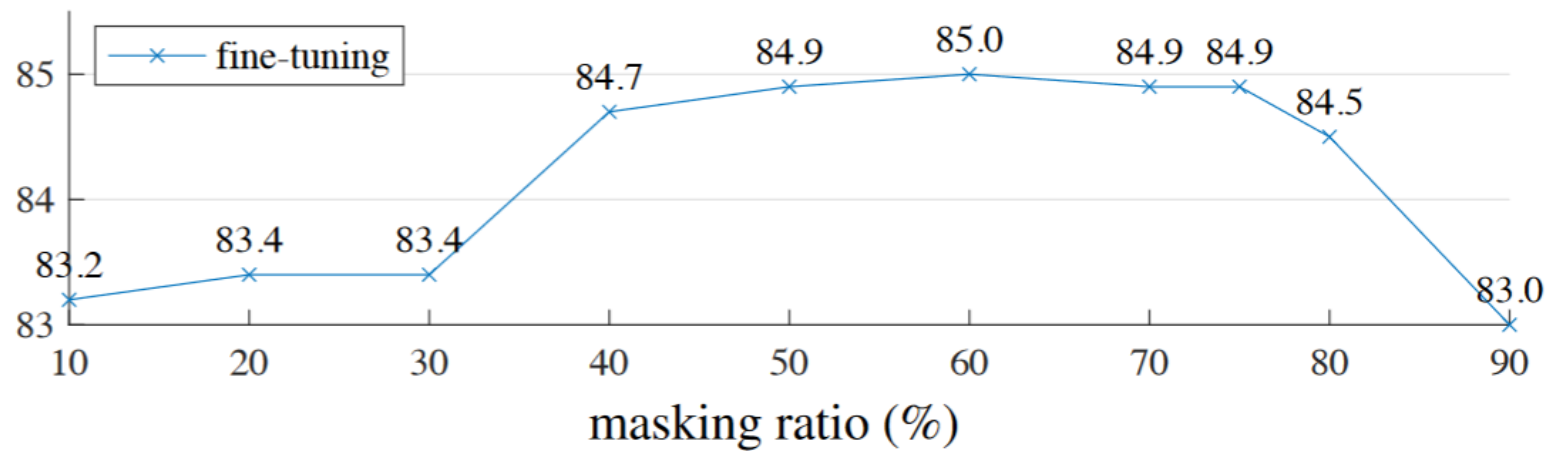

Figure 4. Reconstructions of ImageNet *validation* images using an MAE pre-trained with a masking ratio of 75% but applied on inputs with higher masking ratios. The predictions differ plausibly from the original images, showing that the method can generalize.



method	pre-train data	AP ^{box}		AP ^{mask}	
		ViT-B	ViT-L	ViT-B	ViT-L
supervised	IN1K w/ labels	47.9	49.3	42.9	43.9
MoCo v3	IN1K	47.9	49.3	42.7	44.0
BEiT	IN1K+DALLE	49.8	53.3	44.4	47.1
MAE	IN1K	50.3	53.3	44.9	47.2

Table 4. **COCO object detection and segmentation** using a ViT Mask R-CNN baseline. All entries are based on our implementation. Self-supervised entries use IN1K data *without* labels. Mask AP follows a similar trend as box AP.

Conclusion

- With the right “pretext” tasks and architectures, we are pretty close to matching supervised performance with self-supervised approaches. But it takes some work (longer training, bigger models, precise hyperparameter tuning)
- SimCLR and Masked AutoEncoder only train on ImageNet images. But couldn't you use a lot more data if you don't need human labels?
- The gelato bet was just a bit premature