

CS4803DGC Design and Programming of Game Console

Spring 2011

Prof. Hyesoon Kim



**Georgia
Tech**



College of
Computing

OpenCL Spec

<http://www.khronos.org/registry/cl/specs/opencl-1.0.48.pdf>

OpenCL

- OpenCL (open computing Language): a framework for writing programs that execute across heterogeneous platforms considering CPUs, GPUs, and other processors.
- Initiated by Apple Inc. Now AMD, Intel, NVIDIA, etc.
- AMD gave up CTM (close to Metal) and decided to support OpenCL
- Nvidia, Intel, Cell support openCL now.



KHRONOS
GROUP

© Copyright Khronos Group, 2009 - Page 6



Processor Parallelism

CPUs

Multiple cores driving performance increase

GPUs

Increasing general purpose data-parallel computing
improving numerical precision

Emerging Intersection

**OpenCL
Heterogeneous Computing**

Multi-processor programming

Graphics APIs and Shading Languages

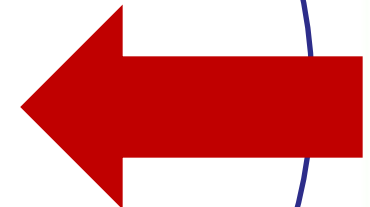
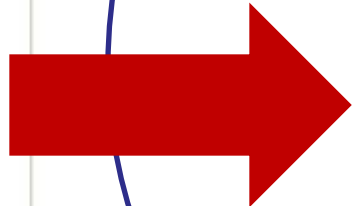



OpenCL standard ...

- Supports both **data**- and **task**-based parallel programming models (CPU: task, GPU: data)
- Utilizes a subset of **ISO C99** with extensions for parallelism
- Defines consistent numerical requirements based on **IEEE 754**
- Defines a **configuration profile** for handheld and embedded devices
- Efficiently interoperates with OpenGL, OpenGL ES and other graphics APIs



Impacts of openCL

- Software developers write parallel programs that will run on many devices
- Hardware developers target openCL
- Enables OpenCL on mobile and embedded silicon



OpenCL Architecture

- **Platform Model**
- **Memory Model**
- **Execution Model**
- **Programming Model**



Platform Model

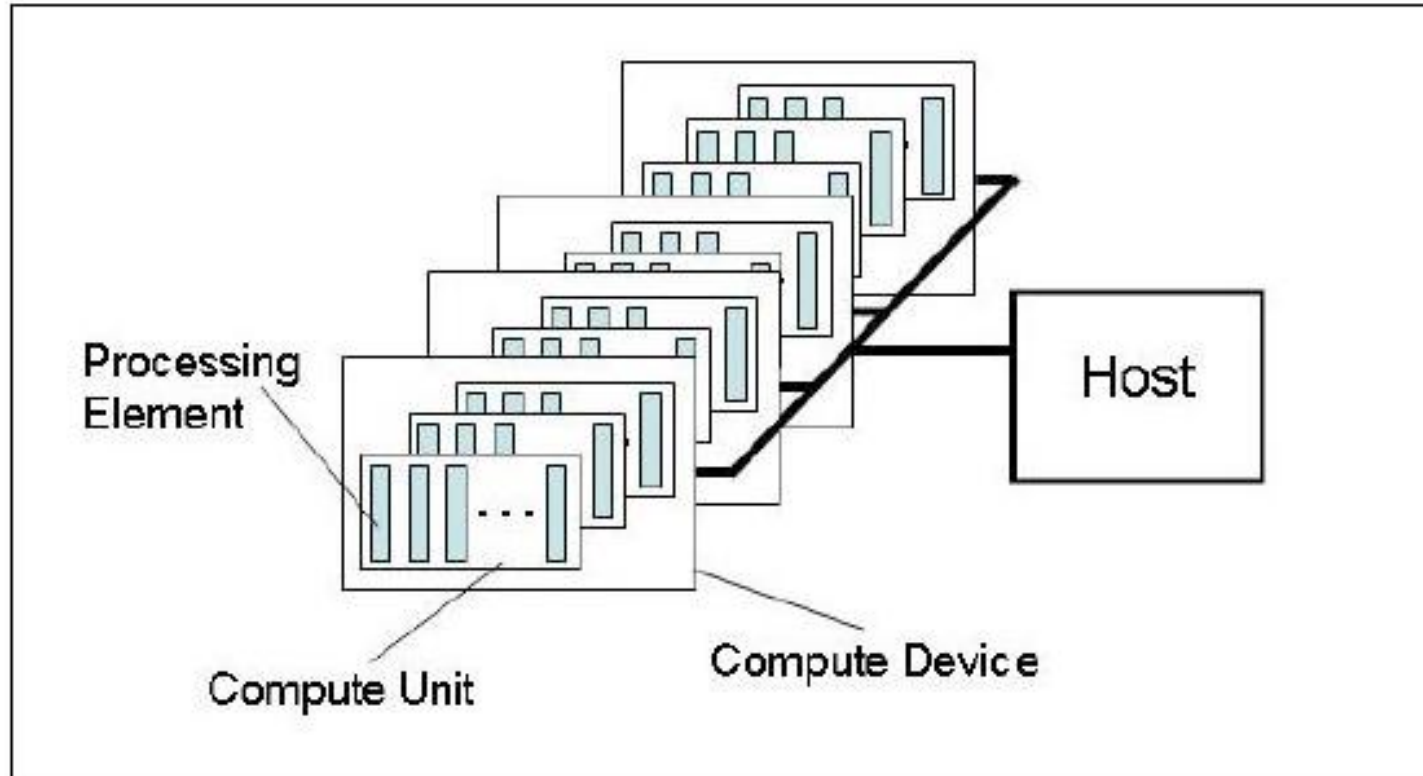

One **Host**+ one or more **compute devices**

- Each compute device is composed of one or more compute units
- Each compute unit is further divided into one or more processing units



Execution Model

- OpenCL Program:
 - Kernels
 - Basic unit of executable code – similar to C function
 - Data-parallel or task-parallel
 - Host Program
 - Collection of compute kernels and internal functions
 - Analogous to a dynamic library



Execution Model

- **Kernel Execution**

- The host program invokes a kernel over an index space called an ***NDRange***
 - NDRange = “N-Dimensional Range”
 - NDRange can be a 1, 2, or 3-dimensional space
- A single kernel instance at a point in the index space is called a ***work-item***
 - Work-items **have unique global IDs** from the index space
 - **CUDA thread Ids**
- Work-items are further grouped into ***work-groups***
 - Work-groups have a unique **work-group ID**
 - Work-items have a unique local ID within a work-group
 - **CUDA Block IDs**



An Example of NDR

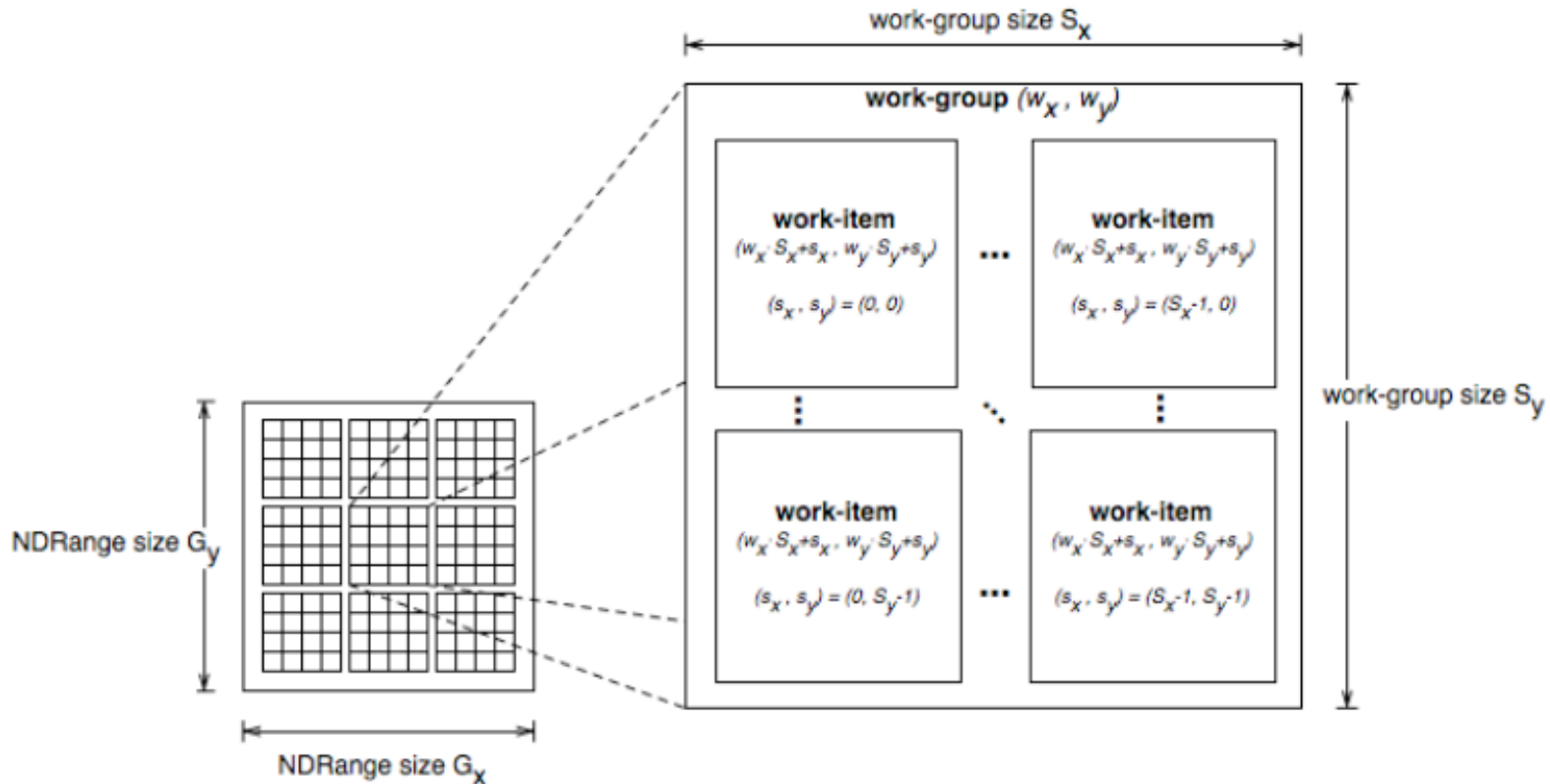

Total number of work-items = $G_x \times G_y$

Size of each work-group = $S_x \times S_y$



Context and Command Queues

- **Contexts are used to contain and manage the state of the “world”**
- **Kernels are executed in contexts defined and manipulated by the host**
 - Devices
 - Kernels - OpenCL functions
 - Program objects - kernel source and executable
 - Memory objects
- **Command-queue - coordinates execution of kernels**
 - Kernel execution commands
 - Memory commands - transfer or mapping of memory object data
 - Synchronization commands - constrains the order of commands
- **Applications queue compute kernel execution instances**
 - Queued in-order
 - Executed in-order or out-of-order
 - Events are used to implement appropriate synchronization of execution instances



Command Queues

- Command queues associate a context with a device
 - Despite the figure below, they are not a physical connection

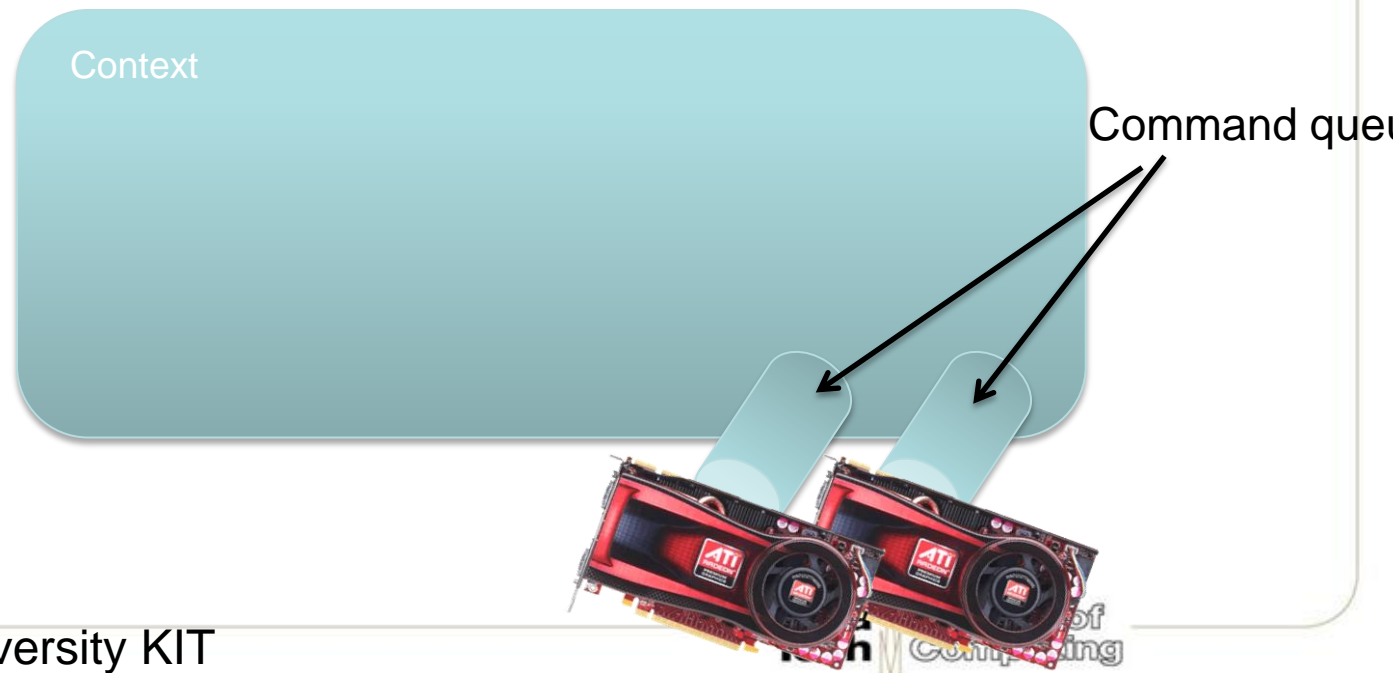



Memory Objects

- Memory objects are OpenCL data that can be moved on and off devices
 - Objects are classified as either buffers or images
- Buffers
 - Contiguous chunks of memory – stored sequentially and can be accessed directly (arrays, pointers, structs)
 - Read/write capable
- Images
 - Opaque objects (2D or 3D)
 - Can only be accessed via `read_image()` and `write_image()`
 - Can either be read or written in a kernel, but not both

OpenCL Steps

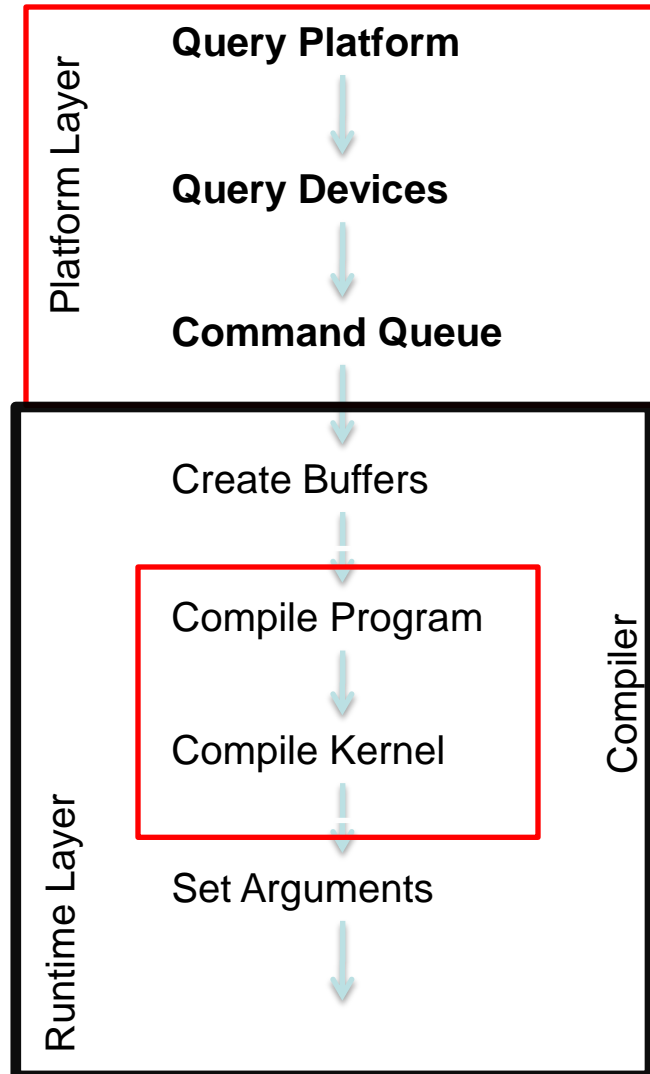

Memory Model

- Shared memory
 - Relaxed consistency
 - (similar to CUDA)
- Global memory
 - Global memory in CUDA
- Constant memory
 - Constant memory in CUDA
- Local memory (local memory to work group)
 - Shared memory in CUDA
- Private memory (private to a work item)
 - local memory in CUDA

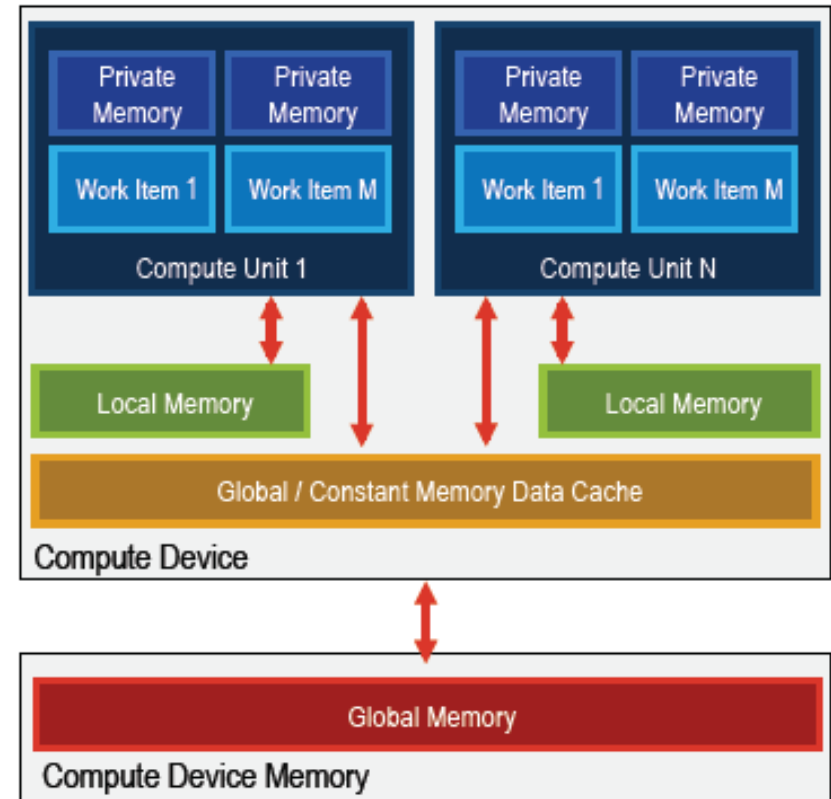



Memory Region

	Global	Constant	Local	Private
Host	Dynamic allocation Read/write access	Dynamic allocation Read/write access	Dynamic allocation No access	Dynamic allocation No access
Kernel	No allocation Read/Write access	Static allocation Read-only access	Static allocation Read/write access	Static allocation Read/write access



Memory Consistency

- a relaxed consistency memory model
 - Across work-items (threads) no consistency
 - Within a work-item (thread) load/store consistency → in order execution
 - Consistency of memory shared between commands are enforced through synchronization



Data Parallel Programming Model

- **Define N-Dimensional computation domain**
 - Each independent element of execution in an N-Dimensional domain is called a *work-item*
 - N-Dimensional domain defines the total number of work-items that execute in parallel = *global work size*
- **Work-items can be grouped together — *work-group***
 - Work-items in group can communicate with each other
 - Can synchronize execution among work-items in group to coordinate memory access
- **Execute multiple work-groups in parallel**
 - Mapping of global work size to work-group can be implicit or explicit



Task Parallel Programming Model

- Data-parallel execution model must be implemented by all OpenCL compute devices
- Users express parallelism by
 - using vector data types implemented by the device,
 - enqueueing multiple tasks, and/or
 - enqueueing native kernels developed using a programming model orthogonal to OpenCL.



Synchronization

- Work-items in a single-work group
 - Similar to `_syncthreads ()`;
- Synchronization points between commands and command-queues
 - Similar to multiple kernels in CUDA but more generalized.
 - Command-queue barrier
 - Ensure all previously queued commands are executed and memory are reflected.
 - Waiting on an event.



OpenCL Framework

- **OpenCL Platform layer:** The platform layer allows the host program to discover openCL devices and their capabilities and to create contexts.
- **OpenCL Runtime:** The runtime allows the host program to manipulate contexts once they have been created.
- **OpenCL Compiler:** The OpenCL compiler creates program executables that contain OpenCL kernels



Platform Layer

- **Platform layer allows applications to query for platform specific features**
- **Querying platform info (i.e., OpenCL profile)**
- **Querying devices**
 - *clGetDeviceIDs()*
 - Find out what compute devices are on the system
 - Device types include CPUs, GPUs, or Accelerators
 - *clGetDeviceInfo()*
 - Queries the capabilities of the discovered compute devices such as:
 - Number of compute cores
 - NDRange limits
 - Maximum work-group size
 - Sizes of the different memory spaces (constant, local, global)
 - Maximum memory object size



Platform Layer

- **Creating contexts**

```
cl_context    clCreateContext (cl_context_properties properties,
                               cl_uint num_devices,
                               const cl_device_id *devices,
                               void (*pfn_notify)(const char *errinfo,
                                                    const void *private_info, size_t cb,
                                                    void *user_data),
                               void *user_data,
                               cl_int *errcode_ret)
```

- Contexts are used by the OpenCL runtime to manage objects and execute kernels on one or more devices
- Contexts are associated to one or more devices
- Multiple contexts could be associated to the same device
- *clCreateContext()* and *clCreateContextFromType()* returns a handle to the created contexts



Command-Queues

- Command-queues store a set of operations to perform
- Command-queues are associated to a context
- Multiple command-queues can be created to handle independent commands that don't require synchronization
- Execution of the command-queue is guaranteed to be completed at sync points



Memory Objects

- **Buffer objects**

- One-dimensional collection of objects (like C arrays)
- Valid elements include scalar and vector types as well as user defined structures
- Buffer objects can be accessed via pointers in the kernel

- **Image objects**

- Two- or three-dimensional texture, frame-buffer, or images
- Must be addressed through built-in functions

- **Sampler objects**

- Describes how to sample an image in the kernel
- Addressing modes
- Filtering modes



OpenCL C for Compute Kernels

- **Derived from ISO C99**
 - A few restrictions: recursion, function pointers, functions in C99 standard headers ...
 - Preprocessing directives defined by C99 are supported
- **Built-in Data Types**
 - Scalar and vector data types, Pointers
 - Data-type conversion functions: `convert_type<_sat><_roundingmode>`
 - Image types: `image2d_t`, `image3d_t` and `sampler_t`
- **Built-in Functions — Required**
 - work-item functions, `math.h`, read and write image
 - Relational, geometric functions, synchronization functions
- **Built-in Functions — Optional**
 - double precision, atomics to global and local memory
 - selection of rounding mode, writes to `image3d_t` surface



OpenCL C language Restrictions

- Pointers to functions are not allowed
- Pointers to pointers allowed within a kernel, but not as an argument
- Bit-fields are not supported
- Variable length arrays and structures are not supported
- Recursion is not supported
- Writes to a pointer of types less than 32-bit are not supported
- Double types are not supported, but reserved
 - (Newer CUDA support this)
- 3D Image writes are not supported
- Some restrictions are addressed through extensions



OpenCL vs. CUDA

	OpenCL	CUDA
Execution Model	Work-groups/work-items	Block/Thread
Memory model	Global/constant/local/private	Global/constant/shared/local + Texture
Memory consistency	Weak consistency	Weak consistency
Synchronization	Synchronization using a work-group barrier (between work-items)	Using synch_threads Between threads
Compilation	Dynamic compilation	Static compilation

CUDA ? OpenCL?

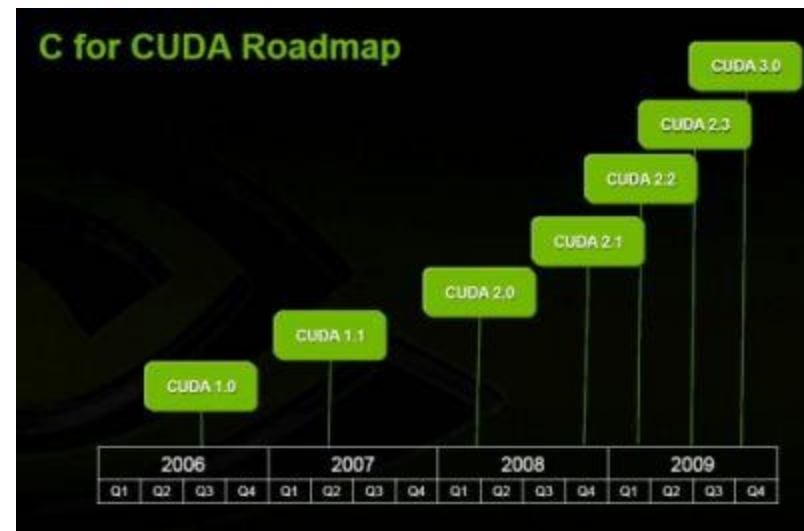
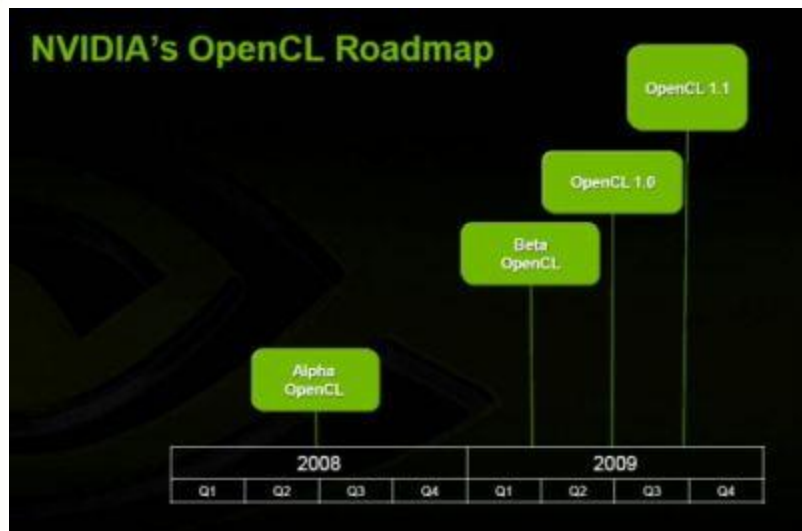

OpenCL and C for CUDA

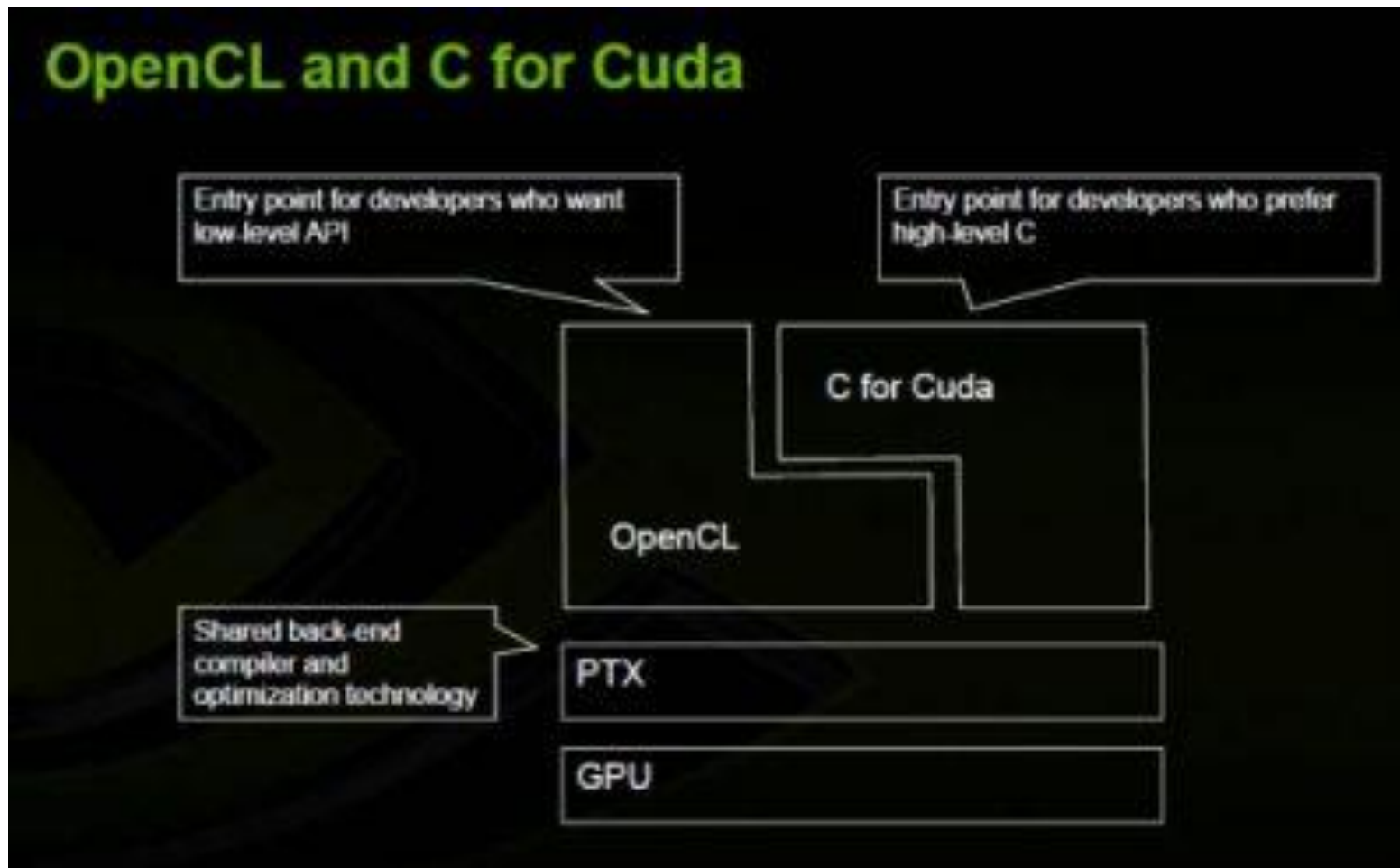

OpenCL Compilation System

- LLVM - Low Level Virtual Machine
- Kernels compiled to LLVM IR
- Open Source Compiler
 - Platform, OS independent
 - Multiple back ends
- <http://llvm.org>

