

Hierarchies and Trees 1 (Node-link)



CS 7450 - Information Visualization
November 2, 2015
John Stasko

Hierarchies



- Definition
 - Data repository in which cases are related to subcases
 - Can be thought of as imposing an ordering in which cases are parents or ancestors of other cases

Hierarchies in the World



- Pervasive
 - Family histories, ancestries
 - File/directory systems on computers
 - Organization charts
 - Animal kingdom: Phylum,..., genus,...
 - Object-oriented software classes
 - ...



Design Exercise

Trees



- Hierarchies often represented as trees
 - Directed, acyclic graph
- Two main representation schemes
 - Node-link (today)
 - Space-filling

Fall 2015

CS 7450

5

Node-Link Diagrams



- Root at top, leaves at bottom is very common

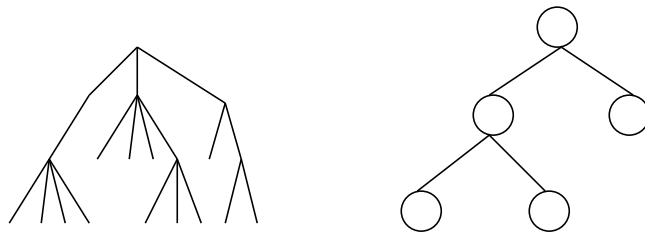

Fall 2015

CS 7450

6

Sample Representation

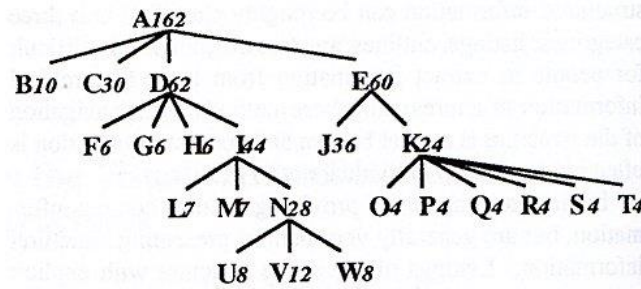

From: Johnson & Shneiderman, '91

Fall 2015

CS 7450

7

<http://elections.nytimes.com/2012/results/president/scenarios>

Election '12



Paths to the White House

FACEBOOK TWITTER

Map | Big Board | Scenarios | Exit Polls

President Obama won a clear victory, but his popular vote margin in several battleground states was very thin. Select a winner in the most competitive states below to explore alternate electoral outcomes.

Fla.	Ohio	N.C.	Va.	Wis.	Colo.	Iowa	Nev.	N.H.
Dem Rep	Dem Rep	Dem Rep	Dem Rep	Dem Rep	Dem Rep	Dem Rep	Dem Rep	Dem Rep
52% 49%	50% 48%	47% 51%	51% 48%	53% 46%	51% 47%	52% 48%	52% 48%	52% 48%

Obama has 431 ways to win 84% of paths | 5 ties 8.50% of paths | Romney has 76 ways to win 14% of paths

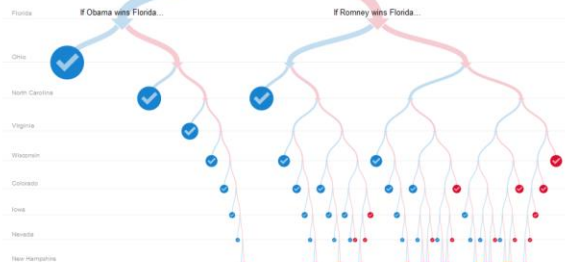

Fall 2015

CS 7450

8

Examples

Good for?

Search

Bad for?

Understanding structure

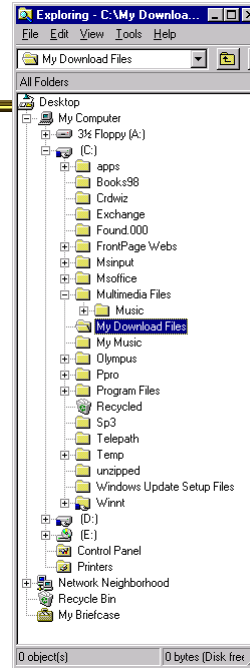
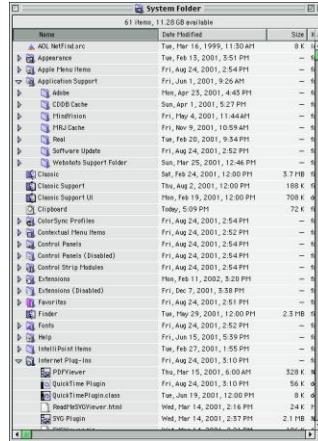

Fall 2015

CS 7450

9

Why Put Root at Top?

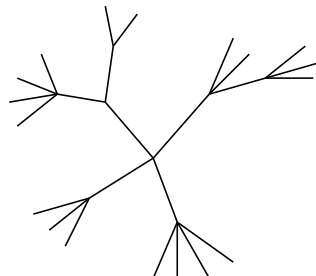

Root can be at center with levels growing outward too

Can any node be the root?

Fall 2015

CS 7450

10

Basic Algorithm

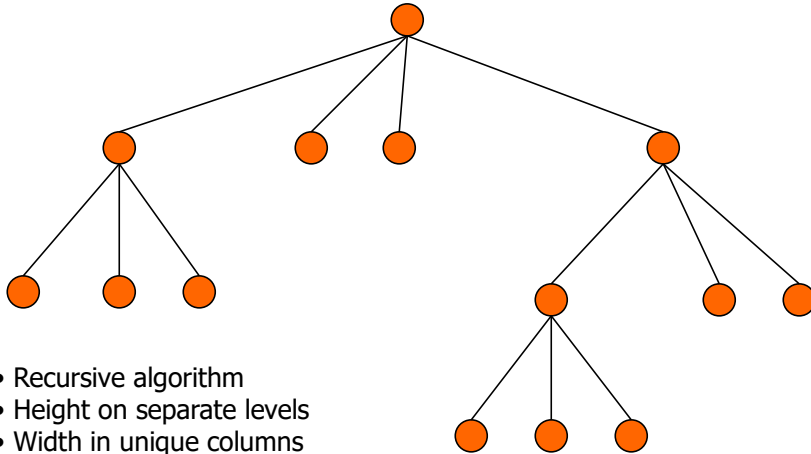

- Recursive algorithm
- Height on separate levels
- Width in unique columns
- Make room for subtrees upwards

Fall 2015

CS 7450

11

Potential Problems



- For top-down, width of fan-out uses up horizontal real estate very quickly
 - At level n , there are 2^n nodes
- Tree might grow a lot along one particular branch
 - Hard to draw it well in view without knowing how it will branch

Fall 2015

CS 7450

12

More Sophisticated

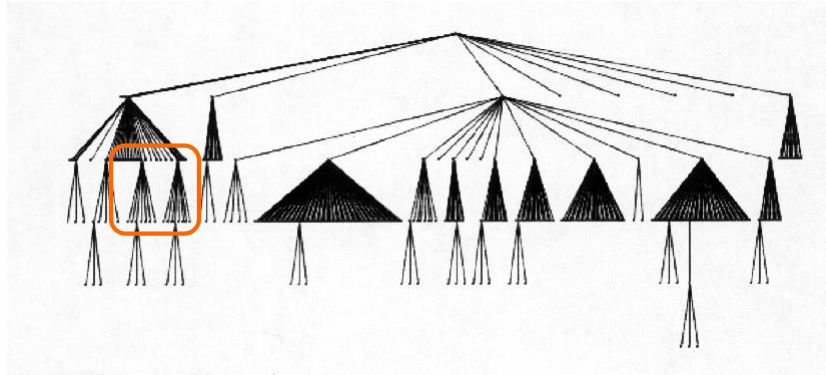

In what way?

- Regions compressed horizontally

Fall 2015

CS 7450

13

Reingold-Tilford Algorithm



Compact layout
Uses symmetry
Depth on levels

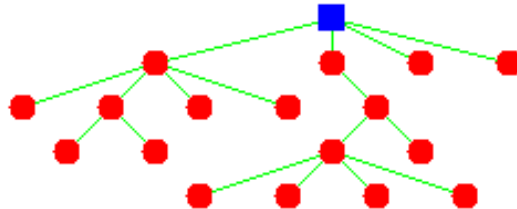

Generalized from binary trees by Walker
Running time improved (linear) by Buchheim et al

Fall 2015

CS 7450

14

Neat Applet

You do drawing
It cleans it up

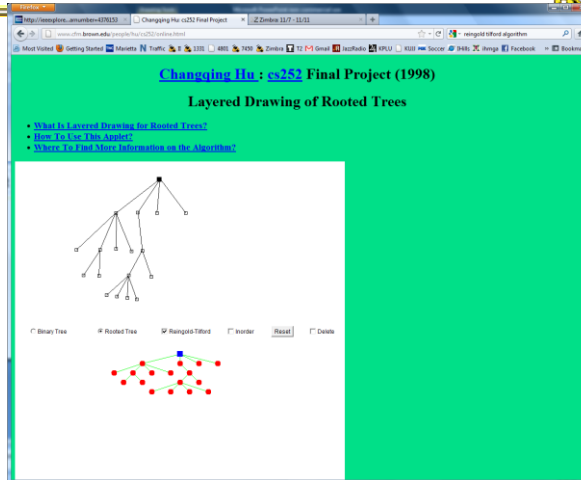

<http://www.cfm.brown.edu/people/hu/cs252/online.html>

Fall 2015

CS 7450

15

InfoVis Solutions

- Techniques developed in Information Visualization largely try to assist the problems identified in the last slide
- Alternatively, Information Visualization techniques attempt to show more attributes of data cases in hierarchy or focus on particular applications of trees

Fall 2015

CS 7450

16

Discuss



- How could we do better?
- What design changes could we make to help?

Fall 2015

CS 7450

17

SpaceTree



- Uses conventional 2D layout techniques with some clever additions

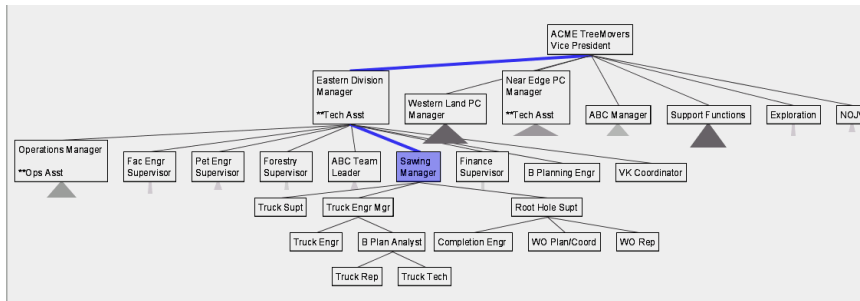

Video & Demo

Grosjean, Plaisant, Bederson
InfoVis '02

Fall 2015

CS 7450

18

Characteristics



- Vertical or horizontal
- Subtrees are triangles
 - Size indicates depth
 - Shading indicates number of nodes inside
- Navigate by clicking on nodes
 - Strongly restrict zooming

Design Features



- Make labels readable
- Maximize number of levels opened
- Decompose tree animation
- Use landmarks
- Use overview and dynamic filtering

3D Approaches



- Add a third dimension into which layout can go
- Compromise of top-down and centered techniques mentioned earlier
- Children of a node are laid out in a cylinder “below” the parent
 - Siblings live in one of the 2D planes

Fall 2015

CS 7450

21

Cone Trees



Developed at
Xerox PARC

3D views of
hierarchies
such as file
systems

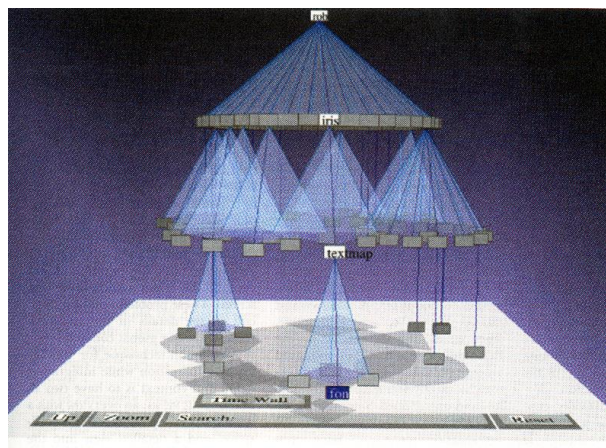

Robertson, Mackinlay, Card
CHI '91

Fall 2015

CS 7450

Video

22

Alternate Views

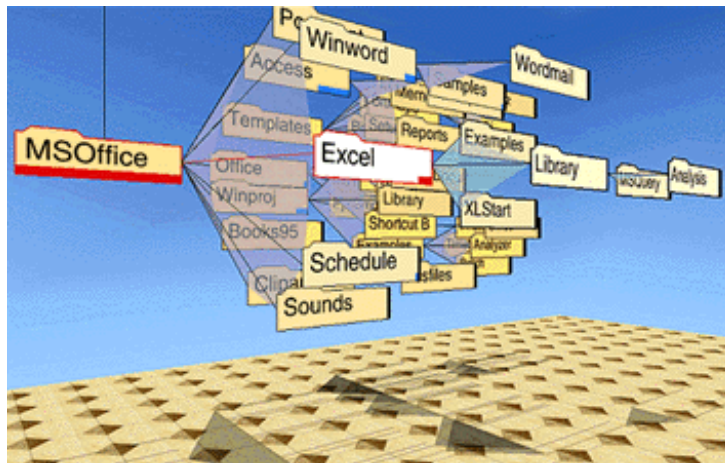

Fall 2015

CS 7450

23

Cone Trees



- Pros & Cons?
 - Discuss

Fall 2015

CS 7450

24

Cone Trees



- Pros
 - More effective area to lay out tree
 - Use of smooth animation to help person track updates
 - Aesthetically pleasing
- Cons
 - As in all 3D, occlusion obscures some nodes
 - Non-trivial to implement and requires some graphics horsepower

Fall 2015

CS 7450

25

Alternative Solutions



- Change the geometry
- Apply a hyperbolic transformation to the space
- Root is at center, subordinates around
- Apply idea recursively, distance decreases between parent and child as you move farther from center, children go in wedge rather than circle

Fall 2015

CS 7450

26

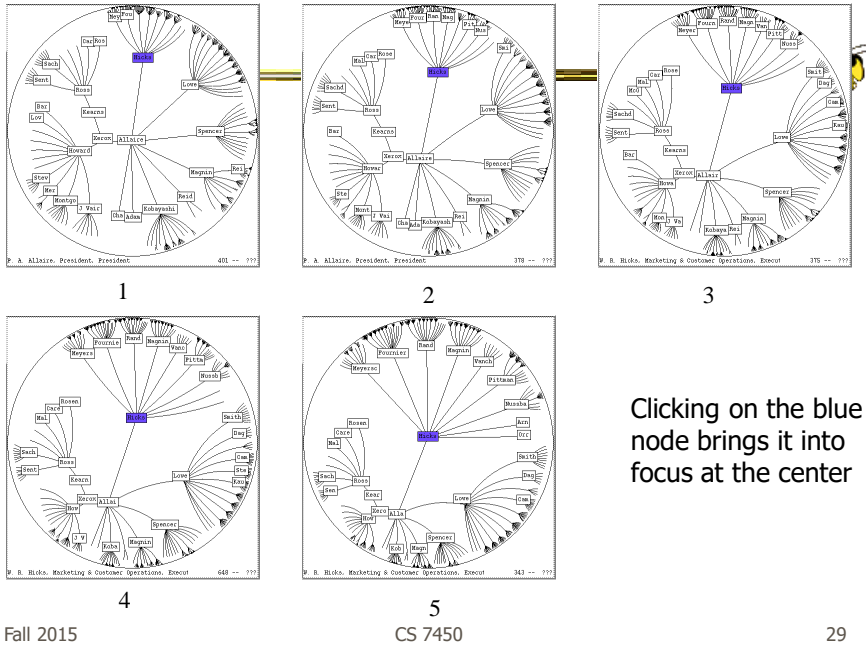

Clicking on the blue node brings it into focus at the center

Watch it Work

- Video
- Demo from prefuse system

Key Attributes



- Natural magnification (fisheye) in center
- Layout depends only on 2-3 generations from current node
- Smooth animation for change in focus
- Don't draw objects when far enough from root (simplify rendering)

Fall 2015

CS 7450

31

Problems



- What might be problems with this approach?

Fall 2015

CS 7450

32

Problems



- Orientation
 - Watching the view can be disorienting
 - When a node is moved, its children don't keep their relative orientation to it as in Euclidean plane, they rotate
 - Not as symmetric and regular as Euclidean techniques, two important attributes in aesthetics

Fall 2015

CS 7450

33

How about 3D?



- Can same hyperbolic transformation be applied, but now use 3D space?
- Sure can
- Have fun with the math!

Fall 2015

CS 7450

34

H3Viewer

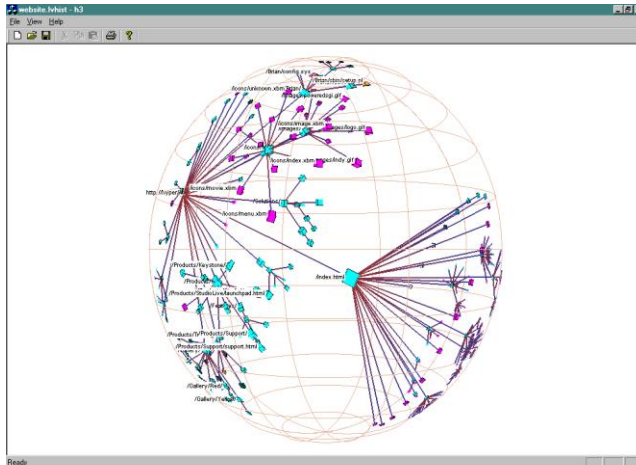

Munzner,
IEEE CG&A '98

[Video](#)

Fall 2015

CS 7450

35

Old School



- After all the interest in 3D and hyperbolic techniques in the '90's, recently, there has been renewed interest in the old 2D methods (just done better)
 - SpaceTree presented earlier
 - Next 3 papers...

Fall 2015

CS 7450

36

Degree-of-Interest Trees



- Problem: Trees quickly degrade into line



- Approach: Use fisheye-like focus & context ideas to control how a tree is drawn

Card & Nation
AVI '02

Fall 2015

CS 7450

37

Approach



- Combine multiple ideas:
 - Expanded DOI computation
 - Logical filtering to elide nodes
 - Geometric scaling
 - Semantic scaling
 - Clustered representation of large unexpanded branches
 - Animated transition

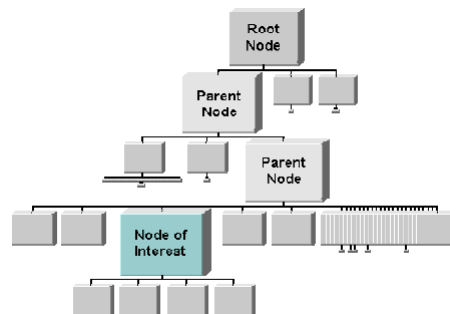

Fall 2015

CS 7450

38

Example Operations

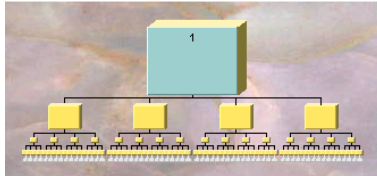

1. Display of a uniform tree of 4 levels

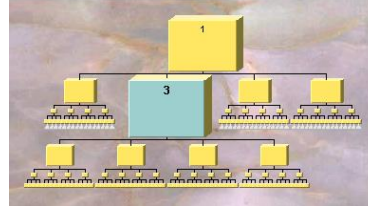

2. Same table with focus on Node 3

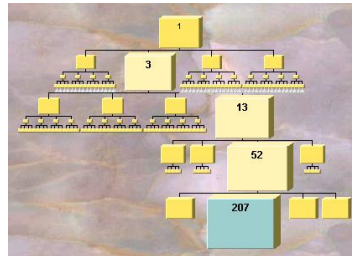

3. Same tree expanded down to a leaf node

Fall 2015

CS 7450

39

Compression



- For nodes: compress to fit (compress in X or in Y)

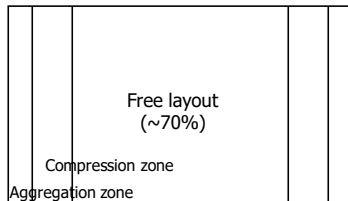

- Within-node compression
 - Data deletion
 - Word abbreviation
 - Node rotation

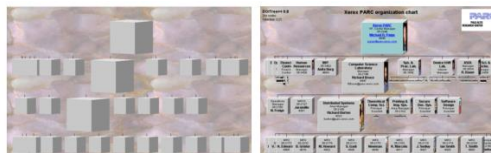

Fall 2015

CS 7450

40

Better View of Org Chart

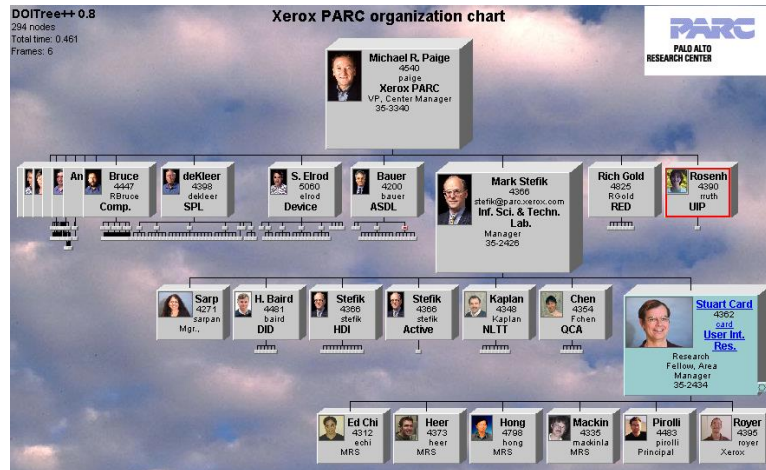

Organization chart with over 400 nodes accessible over WWW through Web browser

Fall 2015

CS 7450

41

FlexTree



- Horizontally-drawn tree with compression along vertical dimension
- One focus is on showing decision trees well
- Contextual multi-foci view
- Basic idea: Push all nodes down as far as you can

Song, Curran & Sterritt
Information Visualization '04

Fall 2015

CS 7450

42

Example

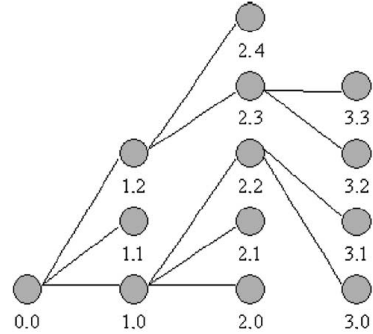
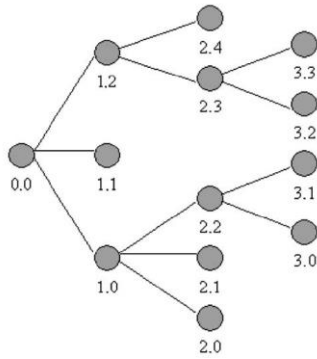

Figure 3 Concept diagram of FlexTree – space between nodes is compressed to achieve a compact view.

Fall 2015

CS 7450

43

Bar Chart and Partial Views

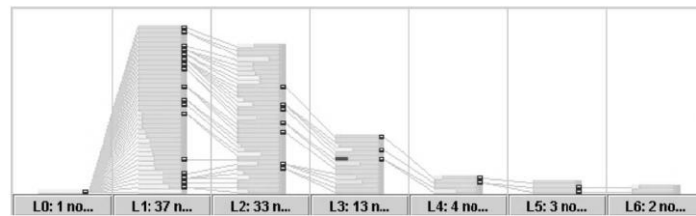

Figure 4 Bar chart view of FlexTree – nodes within the same level stack closely to each other in a space-filling manner.

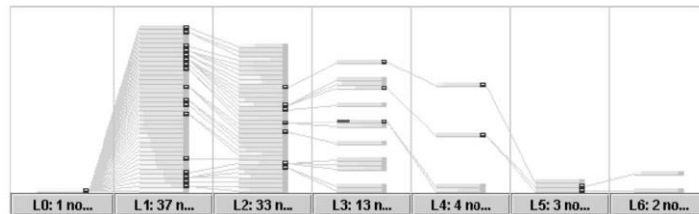

Figure 5 Partial tree view of FlexTree – the structure of the tree is partially revealed.

Fall 2015

CS 7450

44

Full Tree View

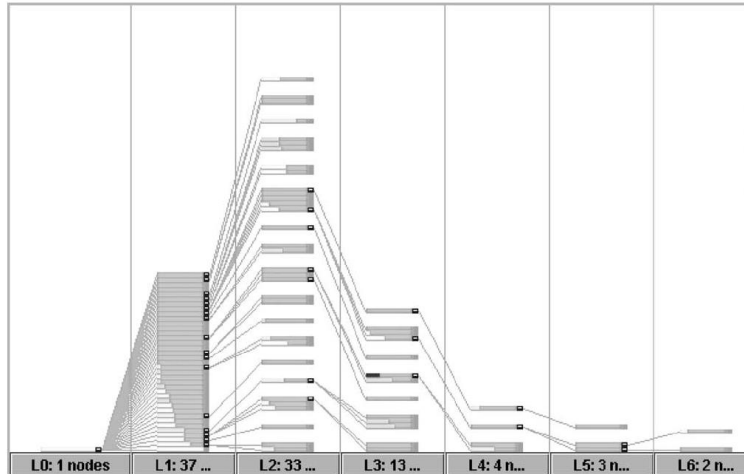

Figure 6 Full tree view of FlexTree -- the structure of the tree is fully revealed.

Fall 2015

CS 7450

45

Node Details

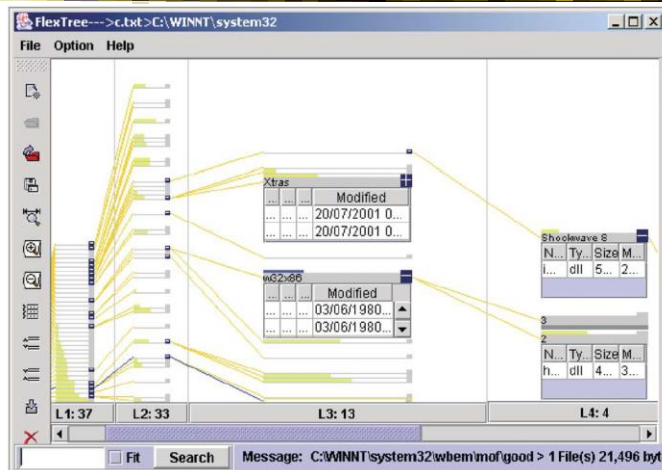

Figure 9 Zooming into multiple foci of interest within the context of the hierarchy. This demonstrates how the user can zoom into a tree and generate details on demand. The $w32 \times 86$ node itself is shown in blue, rather than yellow as the other nodes, because all files in this folder were modified in 1980, which is much earlier than files in the other folders.

Fall 2015

CS 7450

46

Space-Optimized Tree



- Put root node at center, then draw children out radially
- Key: Smart positioning to optimize placement of braches (Voronoi diagram-like approach)

Nguyen & Huang
Information Visualization '03

Fall 2015

CS 7450

47

Space-optimized tree



- Connections + Enclosures
 - Goal: Show relationships and optimize space
- Layout
 - Vertex
 - Subtree
 - Wedge
 - Polygon

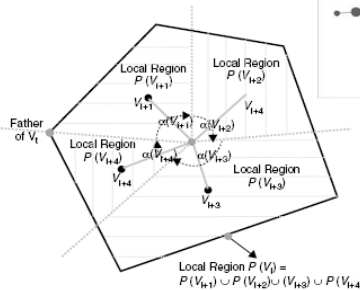
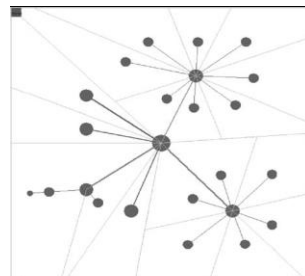

Fall 2015

CS 7450

48

Viewing and Navigation



- Modified Semantic Zooming
 - Reduce density of tree
 - Selected Node to Root
 - History Path

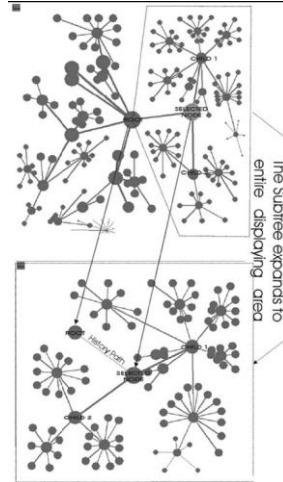

Fall 2015

CS 7450

49

Viewing and Navigation



- Focus + Context
 - Browsing (a)
 - Distortion (b)

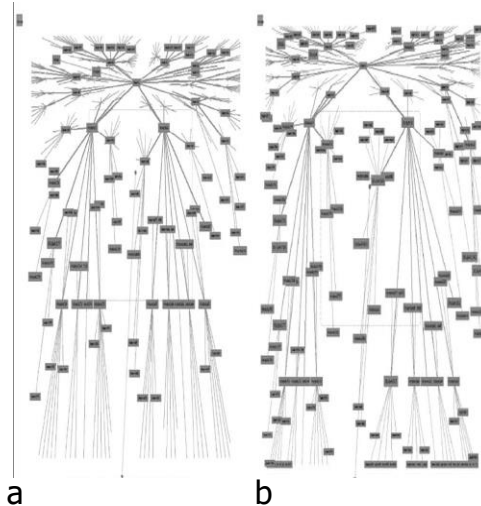
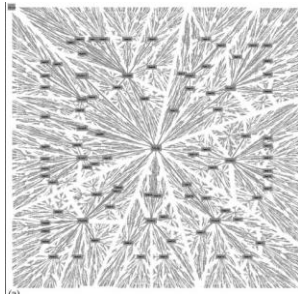

Fall 2015

CS 7450

50



Transitioning a little to next time

Fall 2015

CS 7450

51

CHEOPS



- CHEOPS: A Compact Explorer For Complex Hierarchies
- CRIM's Hierarchical Engine for Open Search



Beaudoin, Parent, Vroomen
Visualization '96

Fall 2015

CS 7450

52

What CHEOPS Is



- Compressed visualization of hierarchical data, using triangle tessellation
- Most or all of the hierarchy can be displayed at once
- Since no Degree-of-Interest (DOI) function required, no major recalculation required when focus changes

Fall 2015

CS 7450

53

Triangle Tessellation



- Overlap/tile the triangles
- The visual object 5 is "overloaded" with the logical nodes E and F
- Insert overlapping triangles between logical nodes

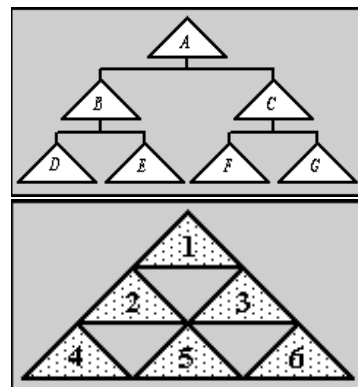

Fall 2015

CS 7450

54

What Tessellation Does (2)



- To get a branch, select a node.
- The branch for the selected node will be “deployed”
- All parent nodes implicitly selected, as well.

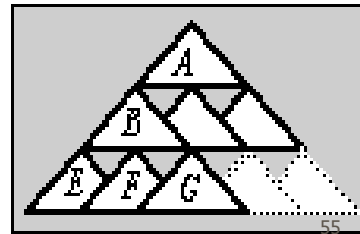
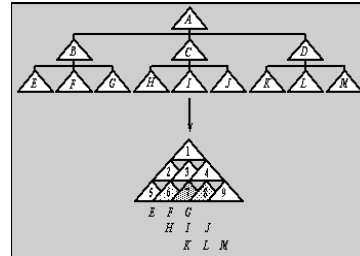

Fall 2015

CS 7450

Getting A Branch With Reused Objects



- Selection
 - By selecting a node, the user sets a “reference state” in the hierarchy
- Pre-selection
 - As the cursor enters a triangle, the branch is highlighted, but not selected
 - Mouse-click to cycle through branches

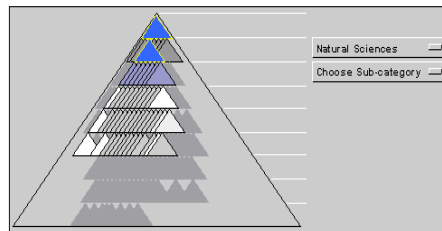

Deployment of *Natural Sciences*

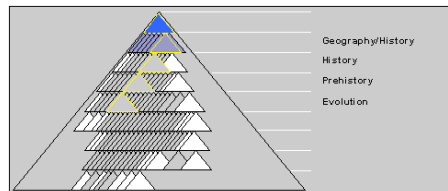

Pre-selection of Evolution₅₆

Demo

Fall 2015

CS 7450

Compare & Critique



- Which of the techniques do you find most appealing?
- Why?

Fall 2015

CS 7450

57

Food for Thought



- Which of these techniques are useful for what purpose?
- How well do they scale?
- What if we want to portray more variables of each case?

Fall 2015

CS 7450

58

Assignments



- HW 4
- HW 5
- Project design documents

Fall 2015

CS 7450

59

Potential Spring Class



- Interest?

Fall 2015

CS 7450

60

Upcoming



- Hierarchies 2 - Space-filling reps
 - Reading
 - Johnson & Shneiderman '90
- Graphs & Networks 1
 - Reading
 - Lee et al '06